

## Polarographic Determination of $K_m$ and $V_{max}$ of Glutathione Reductase

Michaelis Menten constant,  $K_m$ , and  $V_{max}$  for glutathione reductase determined by DC polarography are presented as an alternative methodology to spectrophotometric determinations. A micropolarographic cell is developed for the purpose.

Glutathione ( $\gamma$ -L-glutamyl-L-cysteinyl-glycine) (GSH) is the most abundant non-protein thiol in mammalian cells and it is involved in many cellular functions, especially in antioxidant cellular defense (1-3).

The flavoprotein glutathione reductase (EC 1.6.4.2, NAD(P)H<sub>2</sub>: glutathione oxidoreductase) catalyzes the reduction of oxidized glutathione (GSSG) by NADPH (4) according to:



This enzyme, GR, is responsible for regenerating GSH, which in turn reacts with hydrogen peroxide produced during superoxide ion control (5).

In the literature it is found that GSSG and GSH are determined by spectrophotometric and chromatographic methods (6-8). GR kinetic parameters are only determined by spectrophotometric methods (9). These methods require a large sampling preparation prior to analysis as well as complex reaction determination media.

Since glutathione reductase has great importance in toxicological studies of human fluids, and spectrophotometric and HPLC analysis require long chemical sample preparations that inactivate the enzyme or degrade the substrate (electrochemical measurements need less pre-treatment, if any), electroanalytical detection is very attractive for making such measurements, even *in situ*.

**F1** shows the redox properties of GSH/GSSG. The well-defined polarographic waves correspond to irreversible behavior (10-12) due to the following reactions:

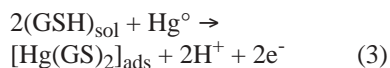
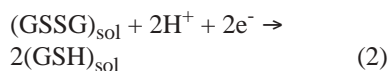

The importance of the electrochemical studies of GSH and GR is clear from the information presented above. In this work we present the polarographic determination of  $K_m$  and  $V_{max}$  for glutathione reductase to illustrate the electrochemical analysis of enzymes as an alternative to the widespread spectrophotometric determinations (13). The information obtained can be used in further experiments for determining GSSG and GSH by enzymatic-electrochemical methods.

### Experimental Procedures

#### Apparatus

A micropolarographic cell (**F2**) was built to minimize costs and residues. The working electrode was the dropping mercury electrode (DME) ( $t = 1\text{ s}$ ); the counter electrode was a C foil; and Ag/AgCl(0.1M KCl) was used as the reference electrode. DC polarograms were performed with a BASi CV-27 Voltammetry Controller and an XYT recorder (Yokogawa 3025). Cell was maintained at constant temperature (25 °C).

#### Chemicals

Analytical grade oxidized glutathione (GSSG), reduced and oxidized adenine dinucleotide phosphate (NADPH, NADP<sup>+</sup>), Tris-hydroxymethyl-aminomethane (Tris, buffer substance), and yeast (GR) (0.54

mg protein/mL and 190 U/mg) were obtained from Sigma. GR was used in the presence of 1 mM EDTA. Methyl-red was used as a maximum suppressor and potassium nitrate as the electrolyte.

#### Methods

All polarograms were performed from  $E_i = 0.260\text{ V}$  to  $E_f = -1.240\text{ V}$ , scan rate = 5 mV/s, drop time = 1 s. Wet nitrogen bubbling was used to eliminate oxygen from the working solutions.

**F3** shows the polarograms a) 10 mM Tris pH = 8.0, KNO<sub>3</sub> 100 mM solution corresponding to the electrolyte-buffer solution employed (EBS), and b) 1.45 mM GSSG and 2 mM GSH in EBS. The observed polarographic waves correspond to reactions (2) and (3) above.

The polarograms of 2mM NADP<sup>+</sup> and 2mM NADPH in EBS were obtained to determine NADP<sup>+</sup>/NADPH interference. **F4** shows the corresponding polarograms. It is observed that the NAD<sup>+</sup> reduction wave appears very close to that of the GSSG reduction wave. NADPH is not electroactive in EBS, so there is no interference with GSH oxidation wave.

**F5** shows the de-evolution of the DC polarograms of 2mM GSSG, 20 mM NADPH in EBS, and 1 mM EDTA with 5 $\mu$ L of GR stock solution. They show de-evolution of the GSH oxidation wave due to enzymatic catalysis of reaction (1). Production of GSH over a wide range of times is determined. Typical GSH evolution is shown in **F6**. Several concentrations of GSSG were assayed under the same conditions.

## Results and Discussion

From the polarograms above it is clear that GSH oxidation waves can be used to determine the enzymatic activity (EA) from the quantity of GSH produced per minute per enzymatic unit (UE). From the  $I_{lim}$  and a suitable calibration plot, the quantity of GSH produced is obtained per time and UE of GR for each initial GSSG assayed. **F7** shows EA as a function of enzymatic catalysis time.

Four different data analyses were performed to obtain  $K_m$  and  $V_{max}$  values. **T1** shows regression analysis data obtained for each kinetic model employed (14). Linear plots used to calculate EA parameters are shown in **F8** as well.

DC polarography results presented here are suitable, since the mercury drop electrode is the most reproducible electrode and is best to perform quantitative measurements, regardless of its toxicity. Modern polarographic techniques that need less mercury, as well as glassy carbon microdisc electrodes, can be employed in further experiments.

## Conclusion

We report an average  $K_m$  for glutathione reductase of  $1.17 \pm 0.01$  mM and  $V_{max}$  of  $2.3004 \pm 0.0099$   $\mu\text{mol}/\text{min}/\text{EU}$  at  $25^\circ\text{C}$ ,  $\text{pH} = 8.0$  and  $I = 0.1$  determined by DC polarography.

The electroanalytical methodology to characterize kinetically glutathione reductase is shown.

The  $K_m$  value reported and obtained by spectrophotometric methods is 0.7 mM at  $\text{pH} = 7.6$  in a phosphate buffer. Our result is 1.17 mM at  $\text{pH} = 8.0$  in Tris buffer solution. We can see they are the same order of magnitude, in spite of the different pH and reaction media used.

## Acknowledgments

The authors acknowledge financial support from DGAPA IN213695 (UNAM) and technical assistance from Dr. Martha Zentella de Piña and Dr. Rogelio Rodríguez.

**F1.** Redox properties of reduced glutathione, GSH, and oxidized form. GSSG.

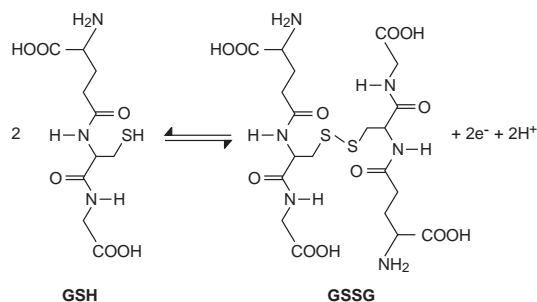

**F2.** Micropolarographic cell,  $V=500 \mu\text{L}$ . 1) DME; 2) Reference electrode; 3)  $\text{C}^\circ$  auxiliary electrode; 4) nitrogen inlet; 5)  $\text{Hg}^\circ$  purge; 6)  $\text{Hg}^\circ$  pool.

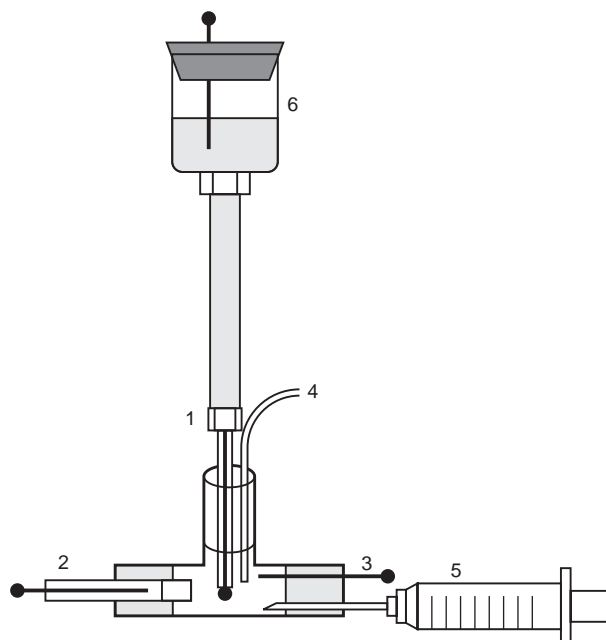

**F3.** DC polarograms of a) Buffer Electrolyte Solution, BSE: 10 mM Tris  $\text{pH} = 8.0$ ,  $\text{KNO}_3$  100 mM; b) 1.45 mM GSSG and 2 mM GSH in EBS.  $E_i = 0.260\text{V}$ ,  $E_f = -1.24\text{V}$ , scan rate = 5 mV/s,  $t = 1$  s.

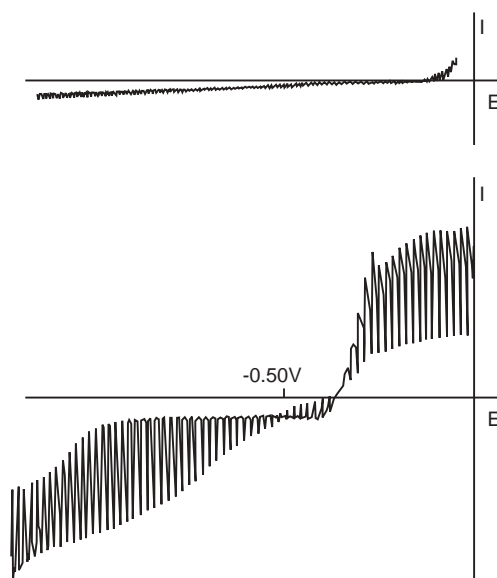

**F4.** DC polarogram of 2 mM NADP<sup>+</sup> and 2 mM NADPH in EBS.  $E_i = 0.260\text{V}$ ,  $E_f = -1.24\text{V}$ , scan rate = 5 mV/s,  $t = 1\text{ s}$ .

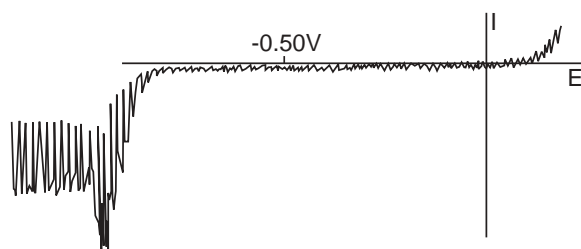

**F5.** Evolution of DC polarograms of 2 mM GSSG, 20 mM NADPH in EBS and 1 mM EDTA with 5  $\mu\text{L}$  of GR stock solution. a) 0 min; b) 26 min; and c) 30 min. of enzymatic action.

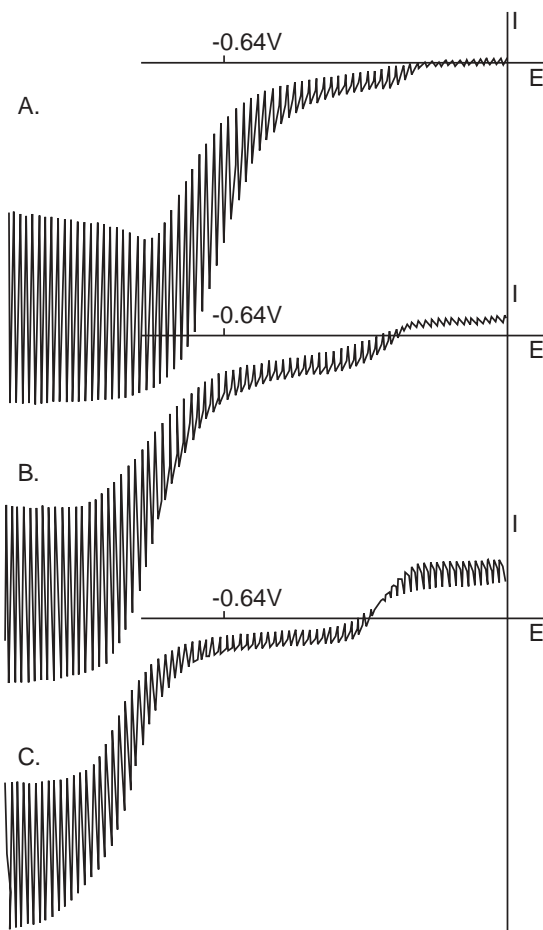

**F6.** GSH production due to enzymatic activity, EA. Sampling time is indicated below polarograms.

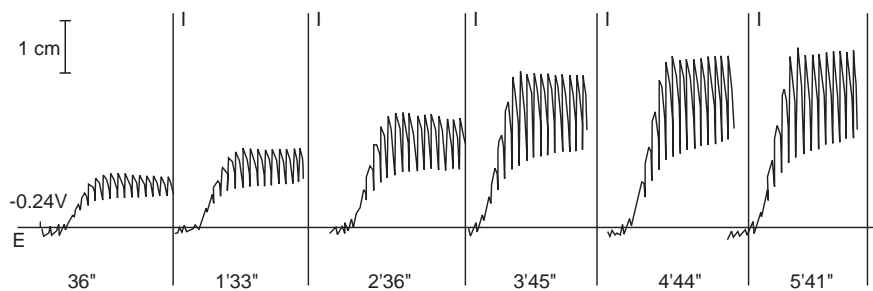

## Biographical Sketches

Heriberto Prado, Jose Luis Ortiz and Patricia Diaz are graduate students in the Faculty of Chemistry at the National University of Mexico.

Dr. Alejandro Baeza is head of the Electroanalytical Chemistry Laboratory at the National University of Mexico.

## References

1. J. Viña , J.R. Viña, and G.T. Sáez, *Life Chem. Rep.* 4 (1986) 1-35
2. A. Meister in "Glutathione: Chemical, Biochemical and Medical Aspects" (D. Dolphin , R. Poulson and O. Avramovic Eds.) pp.367-474, Wiley, New York, 1989.
3. J. Viña in "Glutathione: Metabolism and Physiological Functions." CRC Press. Boca Raton, FL, 1990.
4. R. F. Colman and S. Black, *J. Biol. Chem.* 240 (1965) 1796-1803
5. H. Jaeschke and J.R. Mitchell, *Meth. Enzym.* 186 (1990) 752-758
6. R.F. Burk and K.E. Hill, *Meth. Enzym.* 186 (1990) 759-767
7. T.P. Akerboom and H. Sies, *Meth. Enzym.* 77 (1981) 373-382
8. M. Asensi, *Anal. Biochem.* 217 (1994) 323-328
9. J. Bergmeyer, *Methods of Enzymatic Analysis 3rd Ed. Vol II Ed.* Verlag Chemie, 1983. p. 465-466
10. A. Ulman, *Chem. Rev.* 96 (1996) 1553-1561
11. W. Stricks and I. M. Kolthoff, *J. Am. Chem. Soc.* 74 (1952) 4646-4653
12. M.T. Stankovich and A.J. Bard, *J. Electroanal. Chem.* 75 (1977) 487-505
13. M.K. Ciolksz and J. Jordan, *Anal. Chem.* 65 (1993) 164-168
14. A. Fersht, *Enzyme Structure and Mechanism 2nd Ed.* W.H: Freeman & Co. USA (1995). p. 106-107

**F7.** Enzymatic activity,  $\mu\text{mol}$  of GSSG/min/enzymatic units, determined for several concentrations of initial GSSG.

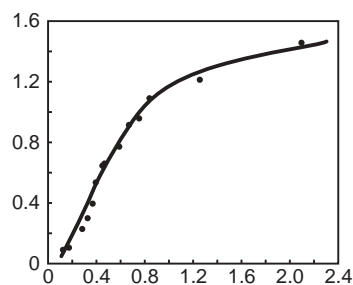

**F8.** Linear plots from data analysis for  $K_m$  and  $V_{max}$  of GR assayed at 25 °C,  $I = 0.1$  and  $\text{pH} = 8.0$ . 1) Lineweaver-Burk, 2) Woolf-Augustinsson-Hofstee, 3) Hanes-Woolf and 4) Eadie-Scatcherd. Results of  $K_m$  and  $V_{max}$  for each model is indicated.

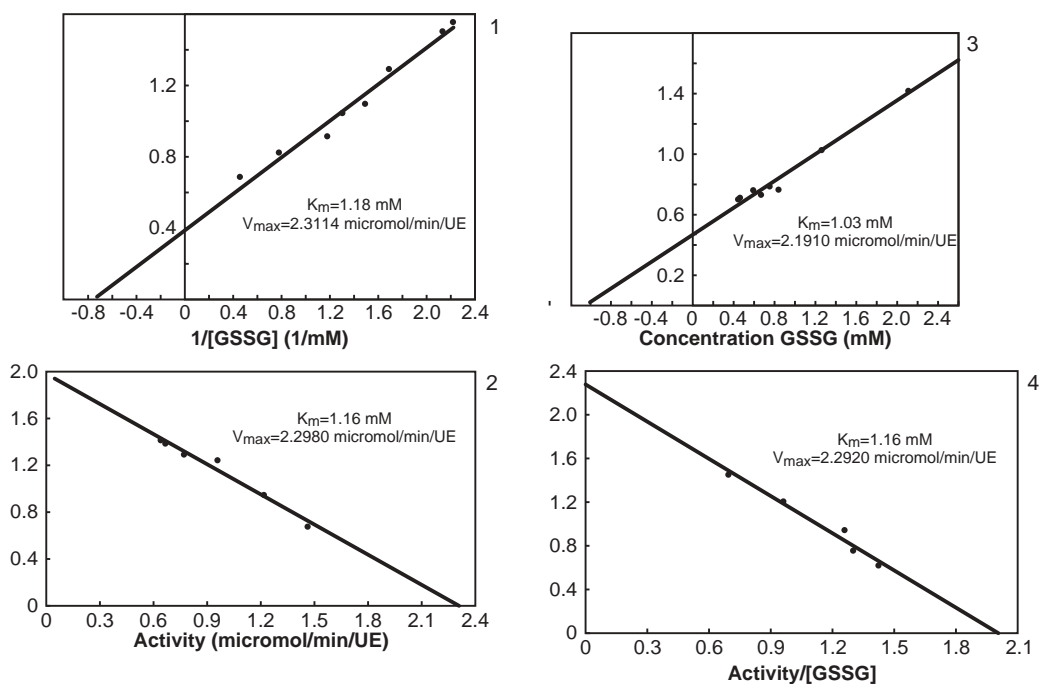

**T1.** Kinetic parameters according to data analysis performed for  $K_m$  and  $V_{max}$  of GR assayed at 25 °C,  $I = 0.1$  and  $\text{pH} = 8.0$ .

Model	Equation	m	b	r	$K_m$ (mM)	$V_{max}$ $\mu\text{mol}/\text{min}/\text{EU}$
LineweaverBurk	$\frac{1}{v} = \frac{K_m}{V_{max}(S)} + \frac{1}{V_{max}}$	0.5886	0.4326	0.9998 (n=5)	1.18	2.31
Augustinsson-Hofstee	$v = K_m \frac{v}{(S)} + V_{max}$	-1.1597	2.2920	0.9978 (n=5)	1.16	2.30
Hanes-Woolf	$\frac{(S)}{v} = \frac{(S)}{V_{max}} + \frac{K_m}{V_{max}}$	0.4564	0.4689	0.9951 (n=5)	1.03	2.19
Eadie-Scatchard	$\frac{v}{(S)} = \frac{1}{K_m}(v) + \frac{V_{max}}{K_m}$	-0.8584	1.9727	0.9978 (n=5)	1.16	2.29