



Aplicación de Espectrometrías Atómicas al Análisis de Alimentos

Curso Extracurricular Semestre 2020-2

Instructora: Ma. Teresa de J. Rodríguez Salazar

Depto. de Química Analítica, Fac. de Química, UNAM

mtjrs@quimica.unam.mx

Dinámica



- **Presentación continua de la ponencia individual**
- **Sección de preguntas al finalizar la presentación**

- **Requisitos para la entrega de constancia:**
 - Haber cubierto toda la sesión presencial**
 - Cumplir con la actividad aprobatoria del curso**

- **La información para la constancia deberá enviarse vía email con el asunto “Curso AEAAA 2020 “:**
 - Nombre completo**
 - ID de la reunión vía zoom**
 - Las iniciales que indicó en el registro del curso**

➤ **Recomendaciones:**

- a) Cerrar micrófonos al iniciar el seminario**
- b) Envíar las preguntas al ponente en chat individual, durante la sesión.**
- c) Abrir el micrófono a solicitud del ponente**
- d) La presentación y constancia se enviarán vía email a solicitud del participante.**
- e) Envíar preguntas y comentarios que queden pendientes, al correo electrónico mtjrs@química.unam.mx**

Objetivo

Proporcionar herramientas teóricas para la adecuada selección de las técnicas analíticas de espectrometría atómica y su aplicación al análisis de elementos.

Introducción



Los productos alimenticios contienen mas de 60 elementos, entre los que se encuentran:

- Los elementos mayores: K, Na, Ca, Mg, Cl, S, P and C
- Los elementos menores y traza (concentraciones menores a a 50 mg/kg):
 - ~ Elementos esenciales: Fe, Cu, I, Co, Mn, Zn, Cr, Ni, Si, F, Mo y Se
 - ~ Elementos esenciales no-tóxicos: Al, B y Sn
 - ~ Elementos no-esenciales y tóxicos al organismo humano: Hg, Pb, As, Cd y Sb

Con base en la Ingesta Diaria Recomendada (RDA, recommended dietary allowances) de la Academia Nacional de la Ciencias de EUA, los elementos se agrupan de la siguiente manera:

- Macronutrientes esenciales (100 mg/día o mas): Ca, Cl, Mg, P, K, Na, S
- Micronutrientes esenciales : Cr, Co, Cu, F, I, Fe, Mn, Se, Zn
- Micronutrientes probablemente esenciales: Ni, Si, Sn, V
- Contaminantes traza : Al, As, Cd, Pb, Hg
- Otros: Sb, Ba, Be, B, Br, Li, Rb, Ag, Sr, Ti

Elementos esenciales minerales nutricionales en el cuerpo humano (Selinus, O. et al, 2005)

<i>Element</i>	<i>Typical amount^a</i>
Ca	1000 g
P	700 g
Mg	20–28 g
Na	1.3 g
K	110–150 g
Mg	20–28 g
Zn	2–2.5 g
Cu	120 mg
Se	20 mg

^a70-kg reference.

Elementos minerales y su función en la salud (Selinus, O. et al, 2005)

Accepted essentials ^a	Suspected essentials ^b	Known or implicated functions
Macronutrient elements		
Ca		Bone structure, nervous transduction
P		Bone structure, membrane structure, metabolic regulation
Mg		Bone structure, electrochemical regulation, enzyme catalysis
Na		Electrochemical regulation, acid-base balance, osmotic control of water distribution
K		Electrochemical regulation, acid-base balance, osmotic control of water distribution
Cl		Electrochemical regulation; acid-base balance, osmotic control of water distribution
Micronutrient elements		
Fe		Oxygen transport, electron transport
Cu		Enzyme catalysis
Zn		Enzyme catalysis, protein structure
I		Metabolic regulation
Se	Ni	Enzyme catalysis, antioxidant protection, redox regulation, anti-tumorigenic metabolites
Mn	Pb	Enzyme catalysis
Mo	As	Potentiation of insulin action in the maintenance of glucose tolerance
Cr	B	Enzyme catalysis
F	V	Protects against dental caries
Co ^c	Si	Single carbon metabolism as active center of the vitamin B ₁₂ molecule Fetal survival and anemia in experimental animals Anemia in experimental animals Reproductive function and growth in experimental animals Bone mineralization in experimental animals Growth in experimental animals Reproductive function and fetal development in animals, calcification in cell culture

^aEssentiality demonstrated on the basis of specific biochemical functions.
^bEssentiality indicated by physiological impairment correctable by supplementation.
^cThe element itself can be used only by ruminants with foregut microflora capable of synthesizing that vitamin. For this reason, Co is considered essential only for ruminants, while the essential form for all non-ruminants including humans is vitamin B₁₂.

Efectos esenciales y tóxicos de elementos traza, en la nutrición humana, animal y de plantas (Adriano, D.C, 2001)

Element	Essential/beneficial to			Potential toxicity to			Comments
	Plants	Animals	Humans	Plants	Animals	Humans	
Ag	No	No	No	Yes	Yes	Yes	Phytotoxic
Al	No	No	No	Yes	Yes		Phytotoxic in low pH soils; toxic to fish in low pH lakes; relatively nontoxic to mammals
As	No	Yes	No	Yes	Yes	Yes	Phytotoxic before animal toxicity; similar geochemical behavior to P; carcinogenic; blackfoot disease (arsenicosis) in South Asia
B	Yes	No	No	Yes			Narrow margin, especially in plants; phytotoxicity is more prone in arid regions; relatively nontoxic to mammals
Ba	No	Possible	No				Insoluble; soluble forms—toxic
Be	No	No	No	Yes	Yes	Yes	Phytotoxic; carcinogenic
Bi	No	No	No	Yes	Yes	Yes	Relatively nontoxic
Cd	No	No	No	Yes	Yes	Yes	Narrow margin; bioaccumulative and phytotoxic; enriched in food chain; carcinogenic; <i>Itai-itai</i> disease (Cd poisoning)
Co	Yes	Yes	Yes	Yes	Yes	Yes	Relatively phytotoxic; role in symbiotic N ₂ fixation; carcinogenic
Cr	No	Yes	Yes	Yes		Yes	Cr ⁶⁺ very toxic and mobile in soils; carcinogenic; Cr ³⁺ relatively nontoxic to mammals
Cu	Yes	Yes	Yes	Yes			Easily complexed in soils; narrow margin for plants; immobile in soils; relatively nontoxic
F	No	Yes	Yes	Yes			Toxic to mammals in high doses; role in dental health; very mobile in soils
Fe	Yes	Yes	Yes			Yes	Fe deficiency in humans common worldwide; phytotoxic in low-pH soils; relatively nontoxic to mammals
Hg	No	No	No		Yes	Yes	Biomagnifies in aquatic food chain; a concern in newly established reservoirs; <i>Minamata</i> disease (Hg poisoning)
Mn	Yes	Yes	Yes	Yes			Wide margin; phytotoxic in low-pH soils; relatively nontoxic to mammals
Mo	Yes	Yes	Yes		5–20 ppm		High enrichment in plants; narrow margin for animals; molybdenosis in livestock
Ni	Yes	Yes	Yes	Yes	Yes	Yes	Very mobile in soils and plants; carcinogenic
Pb	No	No	No	Yes	Yes	Yes	Relatively nonphytotoxic; immobile in soils; human exposure to leaded gasoline, paint, and plumbing; young children most sensitive to Pb poisoning; a global social issue
Sb	No	No	No			Yes	Insoluble; relatively nonphytotoxic
Se	Yes	Yes	Yes	Yes	<4 ppm		Narrow margin for animals (selenocosis); interacts with other trace metals; similar geochemical behavior to S; Keshan and Kaschin-Beck diseases (Se deficiency)
Sn	No	Yes	Yes		Yes	Yes	Relatively nontoxic; very low uptake by plants
Ti	Possible	Possible	No				Insoluble; relatively nontoxic; possibly carcinogenic
Tl	No	No	No	Yes	Yes	Yes	Very mobile in plants; phytotoxic; highly toxic to mammals
V	Yes	Yes	No	Yes	Yes	Yes	Required by green algae; narrow margin and highly toxic in mammals; carcinogenic
W	No	No	No				Very mobile in plants; possibly phytotoxic
Zn	Yes	Yes	Yes	Yes			Wide margin; easily complexed in soils; similar geochemical behavior to Cd; may be lacking in some diets; relatively nontoxic to mammals

*Primarily referring to land-based plants and animals.

Sources: Extracted from Allaway (1968); Chang (1996); Hewitt and Smith (1974); Loehr et al. (1979); Luckey and Venugopal (1977); Miller and Neathery (1977); Underwood (1975, 1977); Van Hook and Shults (1976); Wood and Goldberg (1977); Zingaro (1979).

Aporte del contenido de elementos mayores, menores y traza en alimentos

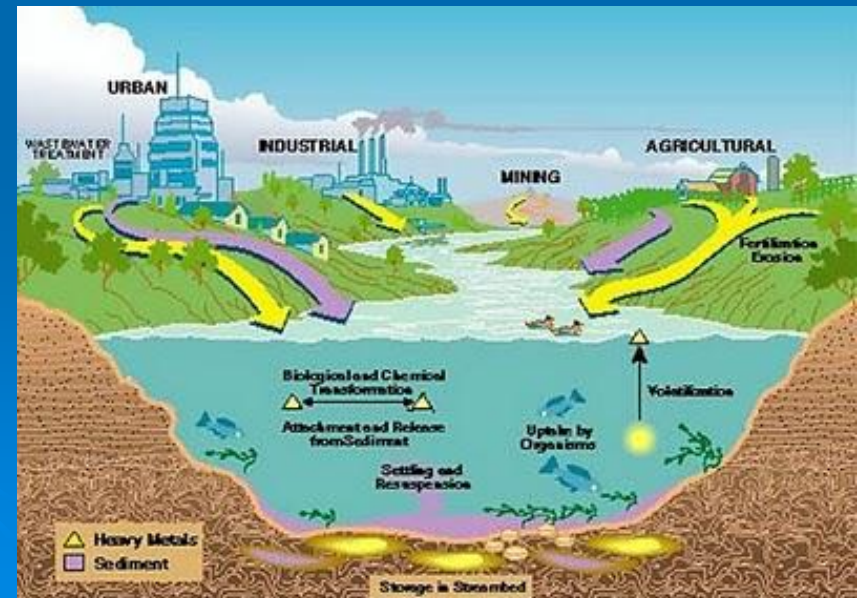

Determinación analítica

- Concentración total
- Relaciones Isotópicas (RI)

Medición de la relación de la señal de una masa respecto a otra.

Las técnicas isotópicas se emplean para identificación y diferenciación de las fuentes naturales y antropogénicas de metales traza.

- Especiación

Actividades analíticas de identificación y/o medición de las cantidades de uno o mas especies químicas individuales en una muestra.

Relaciones Isotópicas

Las especies que tienen el mismo número atómico (mismo número de protones) y propiedades químicas similares; pero diferentes masa atómica, son llamadas isótopos.

Los estudios de variación en la composición isotópica en “muestras naturales” puede dividirse en dos categorías:

- isótopos que se originaron desde la creación de la galaxia y que se consideran estables, y que han permanecido constantes en la composición isotópica a través del tiempo geológico, “no radiogénicos” (ej. ^{204}Pb . 1.35 % abundancia)
- isótopos “radiogénicos” (ej. ^{206}Pb , ^{207}Pb , ^{208}Pb), originados por decaimiento radiactivo (“hijos”) a partir de un isótopo inestable “padre”.



RI Plomo moderno

$$^{206}\text{Pb} / ^{204}\text{Pb} = 18.6 - 19.0$$

$$^{207}\text{Pb} / ^{204}\text{Pb} = 15.6 - 15.67$$

$$^{206}\text{Pb} / ^{207}\text{Pb} = 1.20 \pm 0.015$$

La globalización del mercado de alimentos y la relativa facilidad de transporte entre países y continentes, ha dado lugar al interés de los consumidores por saber el origen de lo que comen.

Ha surgido la publicación de artículos sobre el empleo de las RI como trazadores geográficos para determinar el origen de los alimentos y su autenticidad. Ejemplo de lo anterior son :

$^{207}\text{Pb}/^{206}\text{Pb}$ en la industria del Vino

$^{87}\text{Sr}/^{86}\text{Sr}$ en la distribución del Arroz

Aplicaciones

Las huellas isotópicas pueden usarse para identificar el origen geográfico de una muestra debido a que los organismos acumulan metales del ambiente (agua, alimentos y aire) en los tejidos.

Se han reportando las siguientes investigaciones para diferenciar:

- Especies de atún de los océanos Atlántico y Mediterráneo
- Especies de salmón de 14 ríos distintos de Noruega

La RI de Sr ($^{87}\text{Sr}/^{86}\text{Sr}$) encontrada en las plantas y los animales que se alimentan de las mismas, están relacionadas con el Sr biodisponible en las rocas (indicación de litología única del sitio), lo que representa la suma de los minerales de Sr existentes en la zona.

Variación RI Sr en México

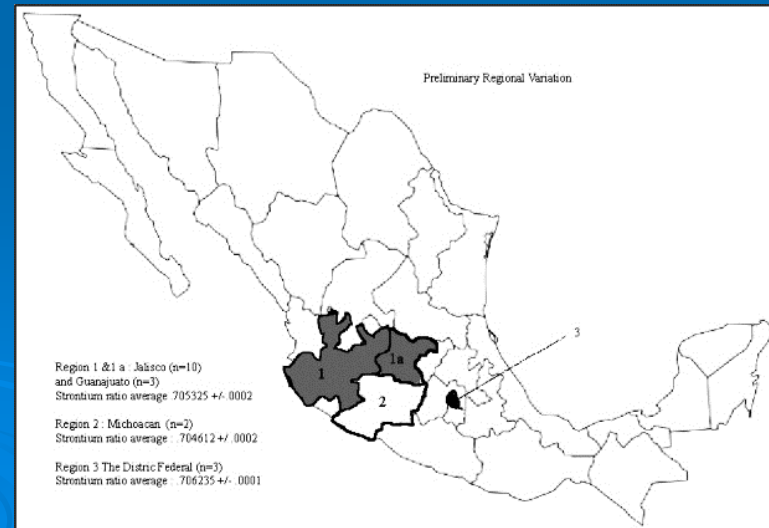

Isótopos de Cu

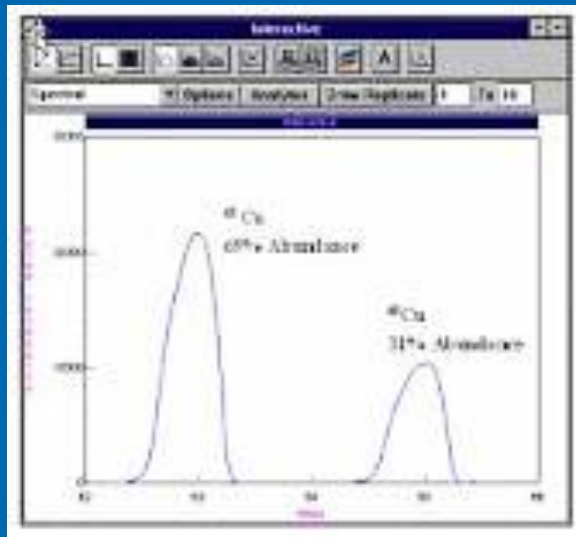

Isótopos de Pb

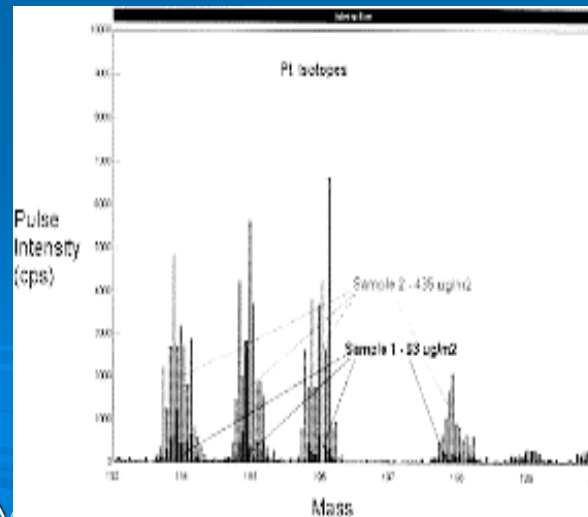

Autenticidad de vinos en función de RI de Pb

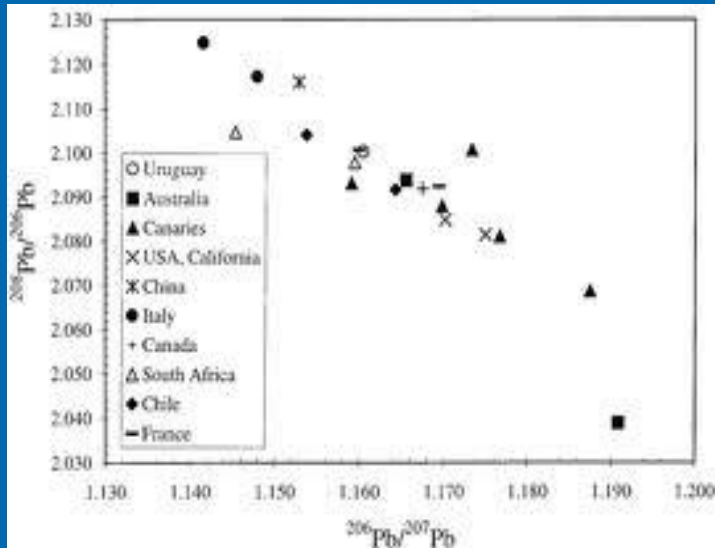

RI Sr para diversos tipos de muestra y diversos orígenes

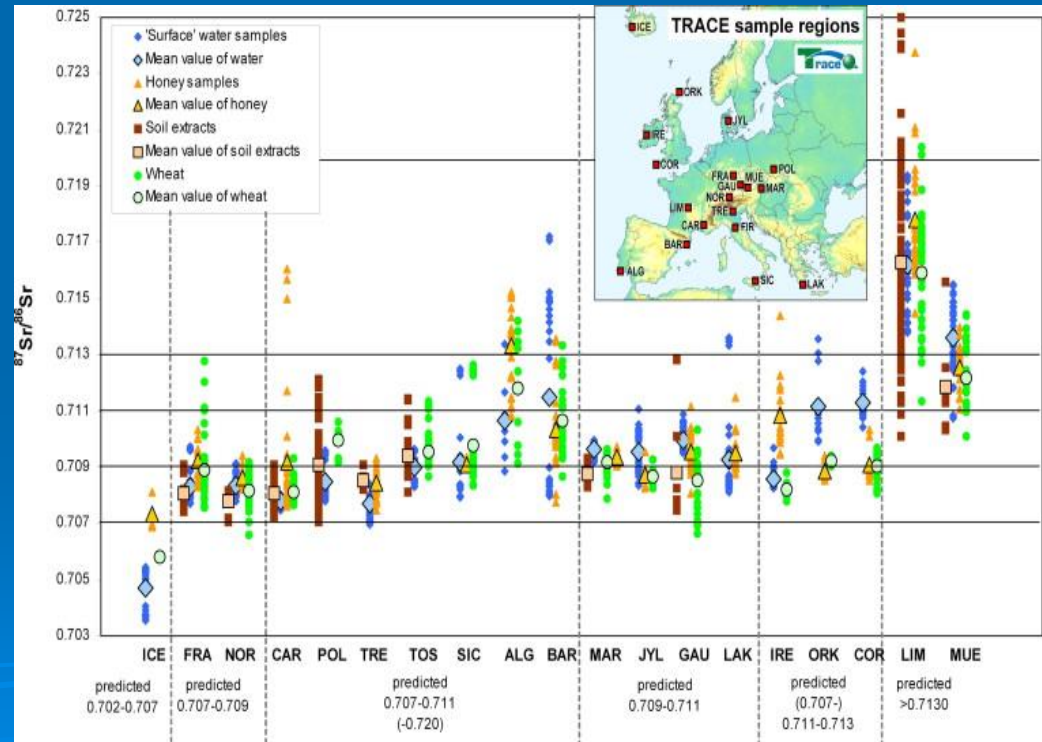
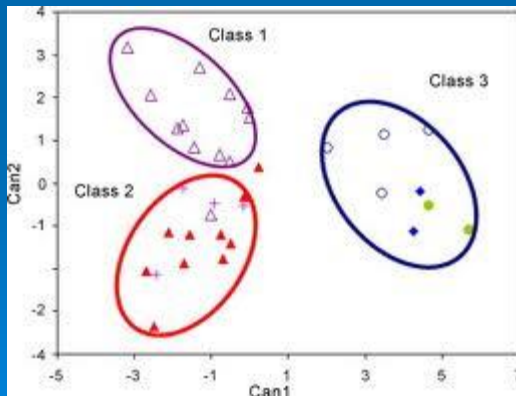

Especiación

Especie química (de un elemento químico): Forma específica de un elemento definida como: composición isotópica, estado electrónico o de oxidación, y estructura molecular o complejo.

El valor nutritivo de un alimento, depende del contenido del mineral y de la biodisponibilidad para el organismo humano.

El análisis de especiación de elementos traza en los alimentos es importante para entender la actividad biológica inherente.

Elementos de interés :

Se, As y Hg (ampliamente estudiados)

Co, Mn, Fe, Zn, Cu y Mo

Especies químicas de Hg

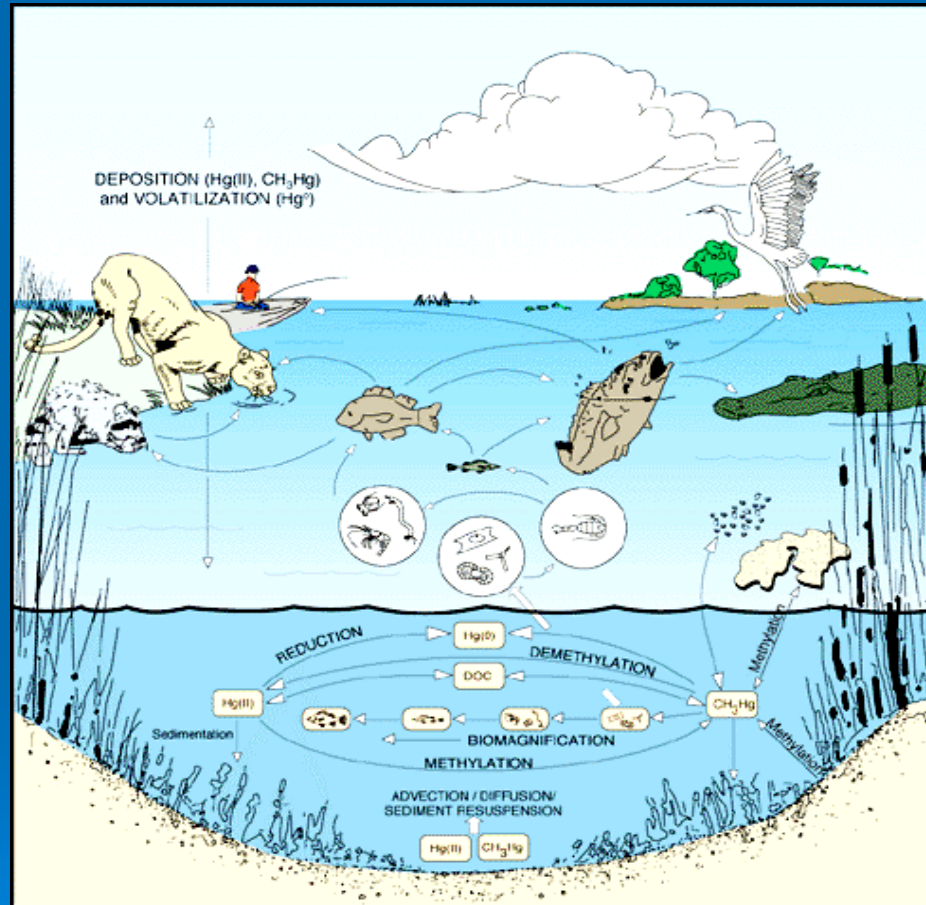

Técnicas Analíticas Espectrométricas

FAAS, ETAAS: Análisis Monoelemental, Corto Intervalo lineal

ICP-AES, ICP-MS: Análisis Multielemental, Amplio intervalo lineal

Espectrometría de Absorción Atómica-Aspiración Directa (Flame Atomic Absorption Spectrometry, FAAS). Determinación a niveles de concentración ppm



Ley de Lambert-Beer

$$T = I / I_0$$

$$A = \log I_0 / I = -\log T = \epsilon bc$$

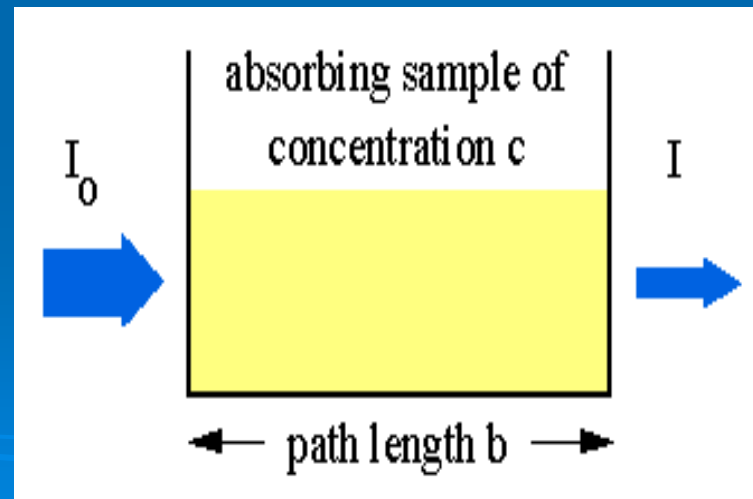

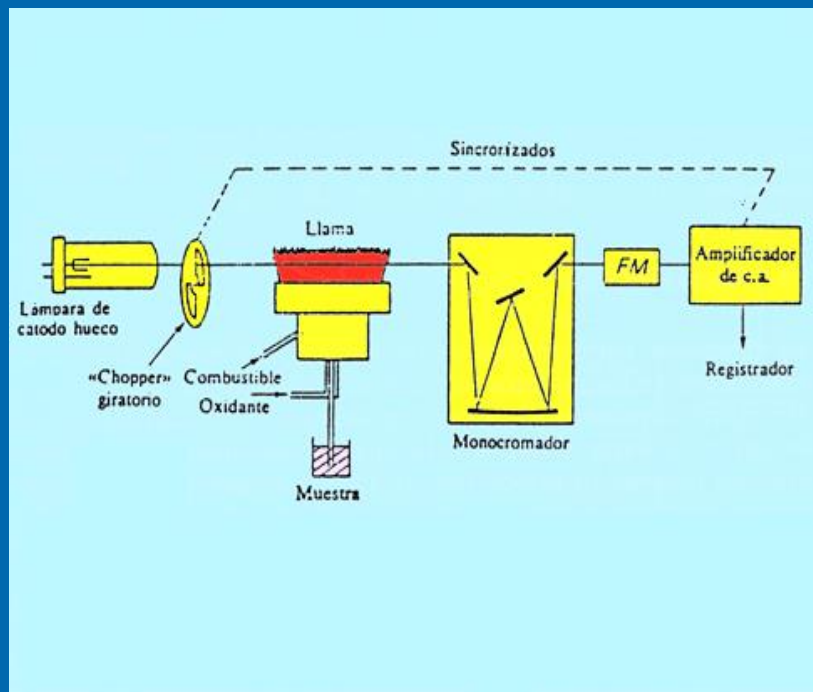

Espectrometría de Absorción Atómica-Horno de Grafito

(Graphite Furnace Atomic Absorption Spectrometry, GFAAS; Electrothermal Atomic Absorption Spectrometry, ETAAS). Determinación a niveles de concentración ppb.



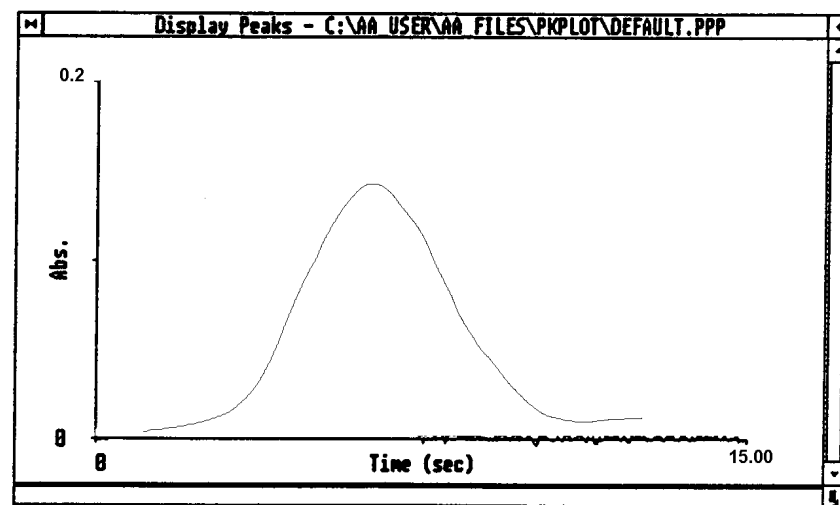
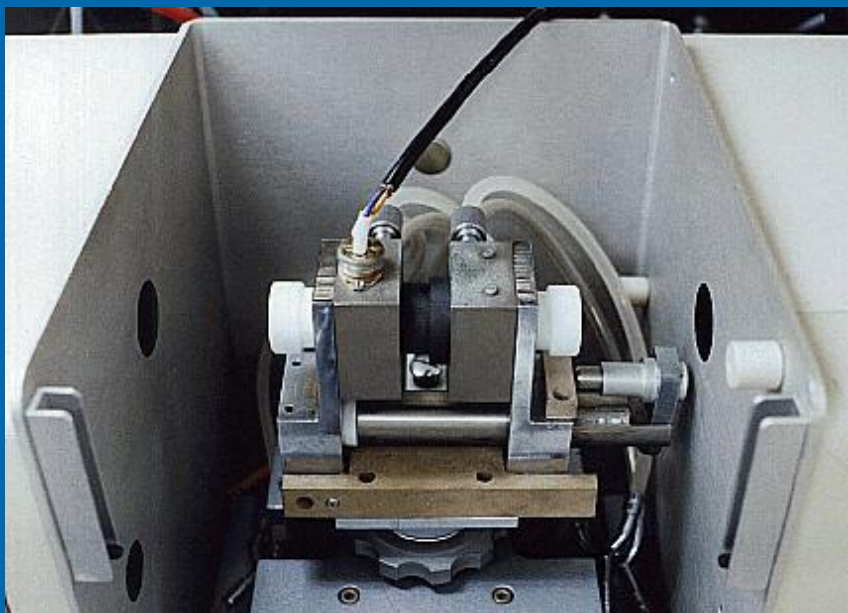

Espectrometría de emisión atómica-plasma inductivamente acoplado (Inductively Coupled Plasma - Atomic Emission Spectrometry, ICP-AES). Determinación a niveles de concentración % y ppm.

Mide la emisión de radiación electromagnética por un átomo en estado excitado (mayor energía) cuando regresa a un estado de menor energía.

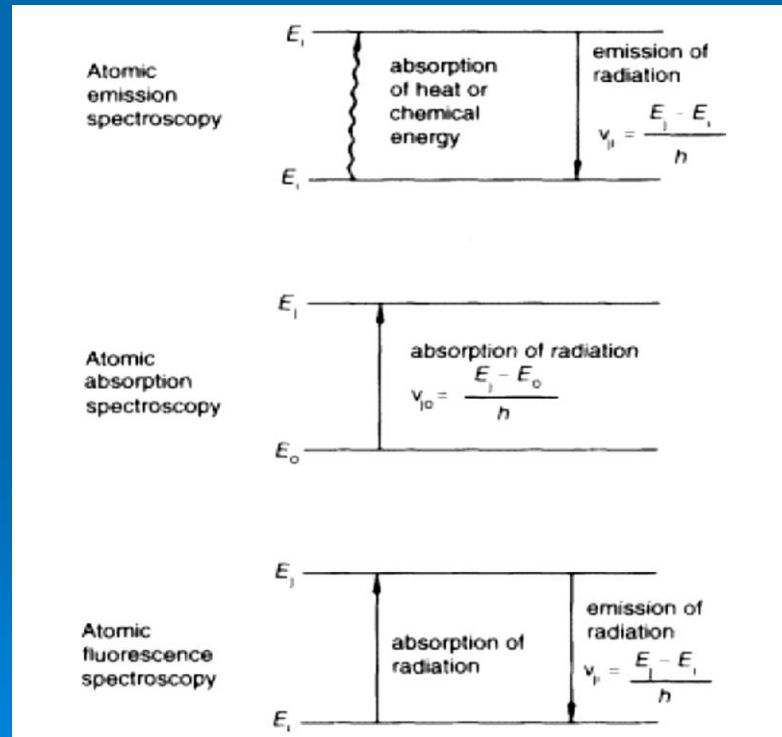

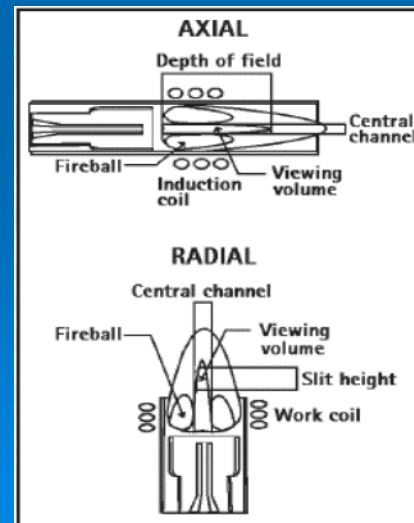
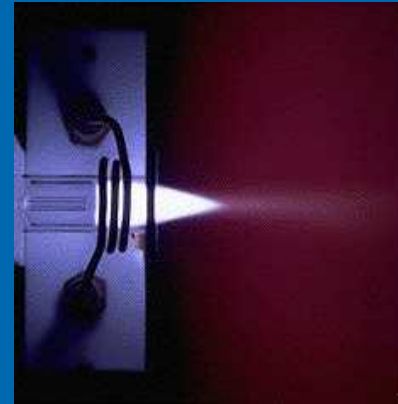

Esquema de instrumentación de Emisión Atómica con fuente de atomización e ionización por Plasma de Acoplamiento Inductivo

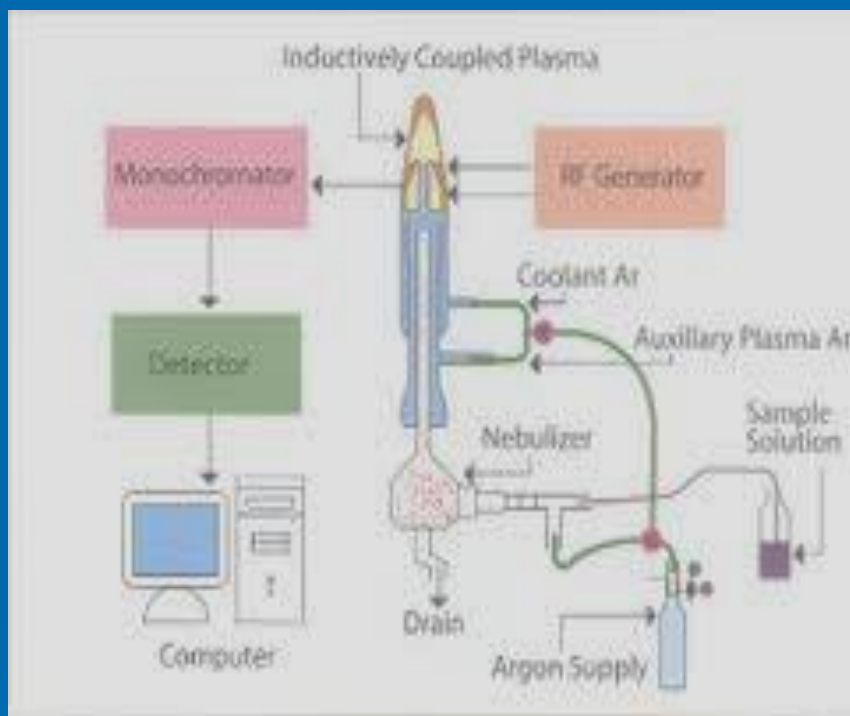

Esquema de la antorcha, y plasma de argón generado

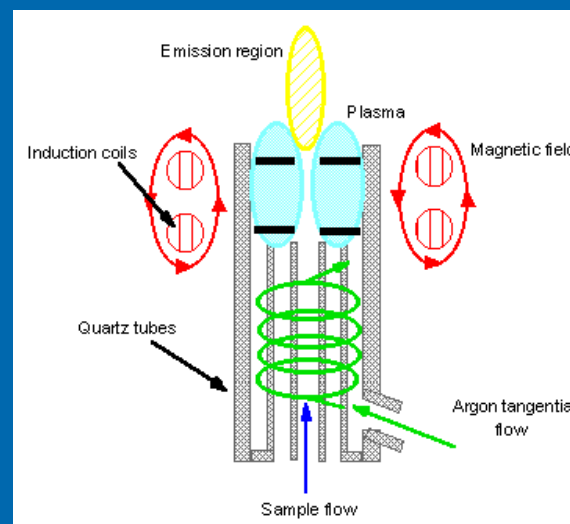

Señal analítica en ICP-AES

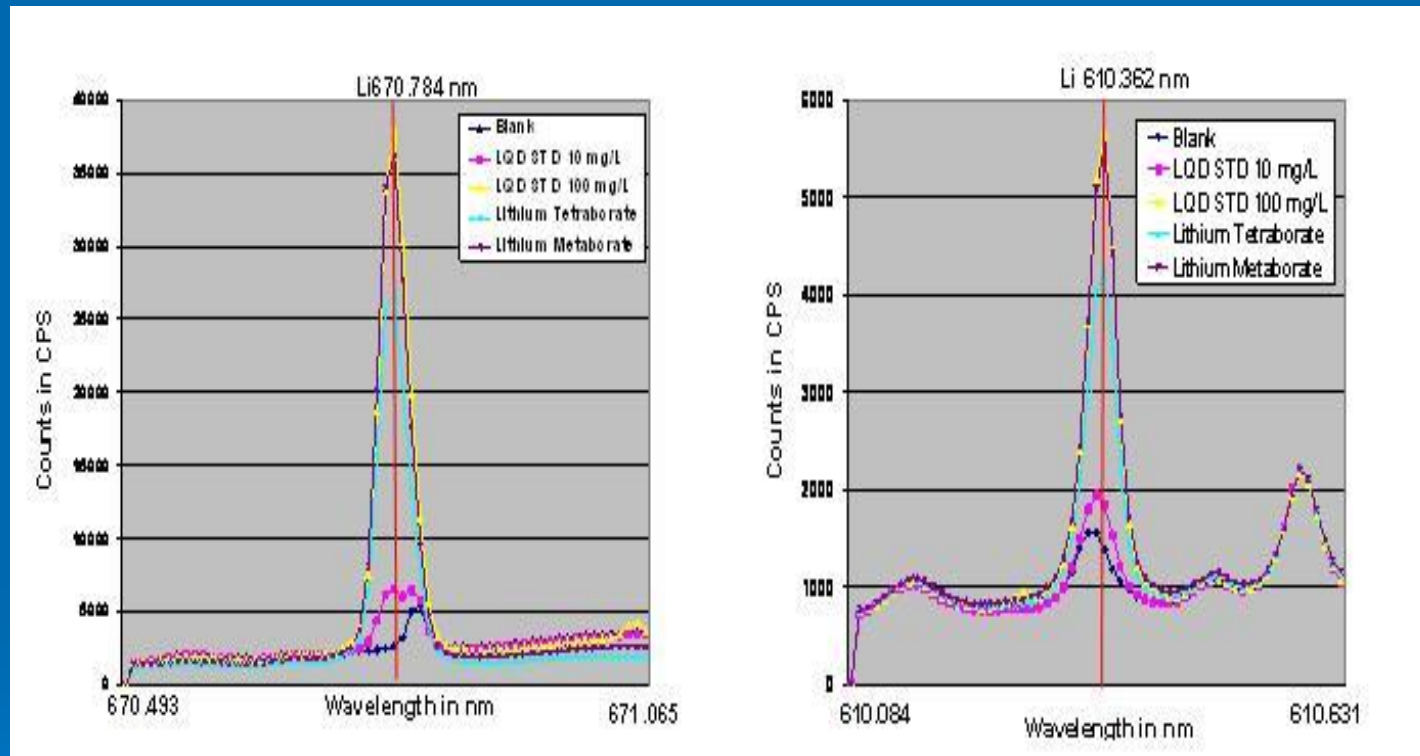

Interferencias espectrales en ICP-AES

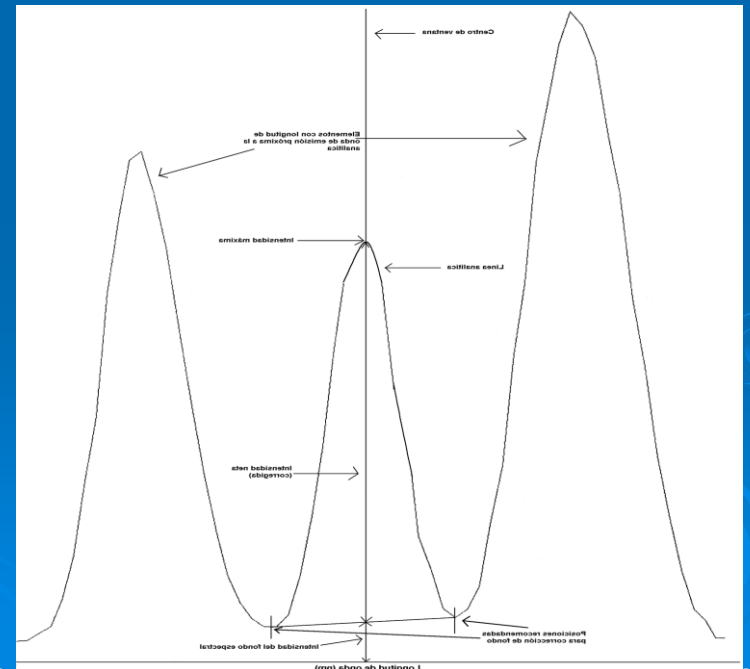
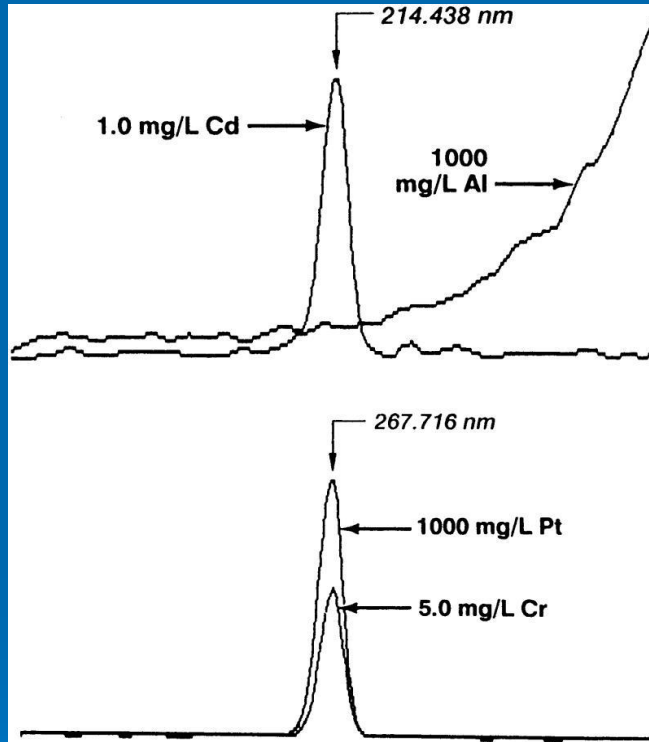

Espectrometría de masas con fuente de ionización por plasma inductivamente acoplado (Inductively Coupled Plasma – Mass Spectrometry, ICP-MS)

La espectrometría de masas es una técnica analítica empleada para la separación e identificación de iones con diferentes valores de relación m/z . La introducción del plasma acoplado, como fuente de iones, ha incrementado la aplicación de lo que se denomina espectrometría de masas inorgánica.



Esquema de Analizador de Masas Cuadrupolar

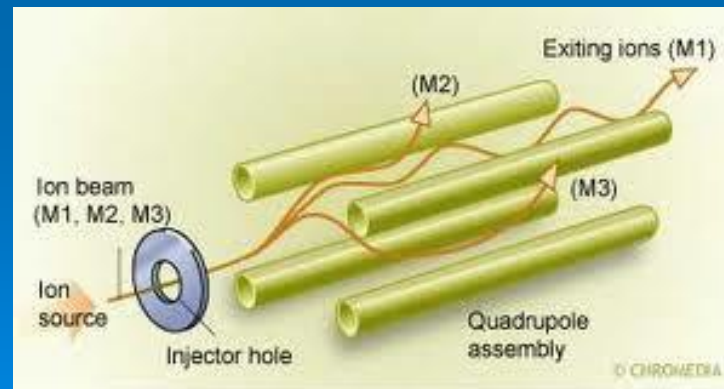
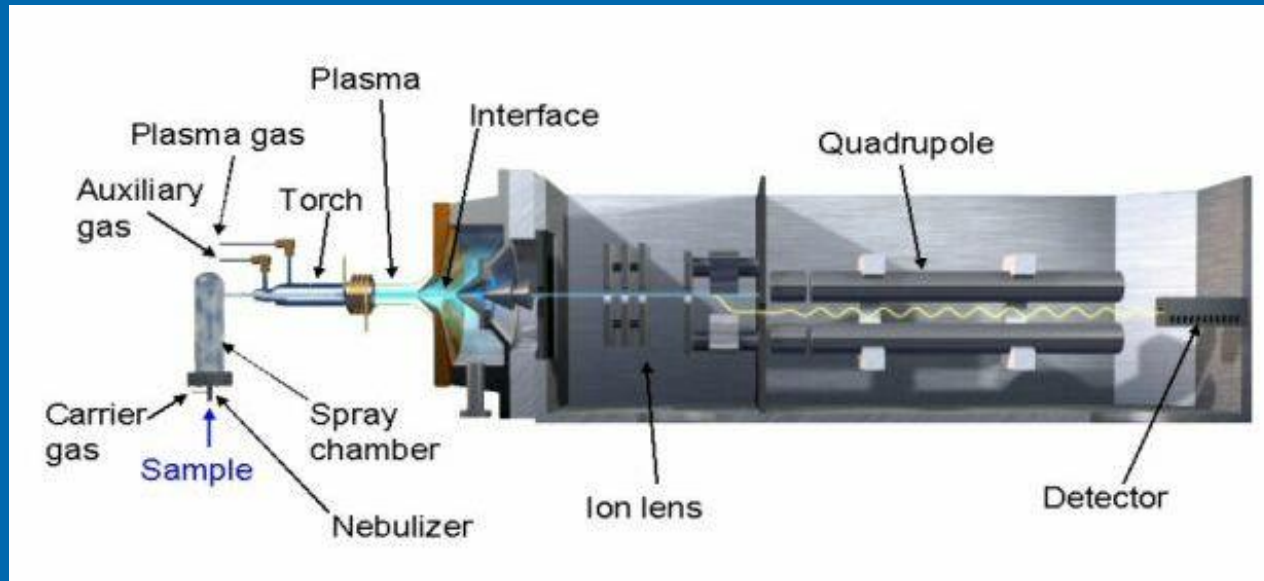

Señal analítica en ICP-MS

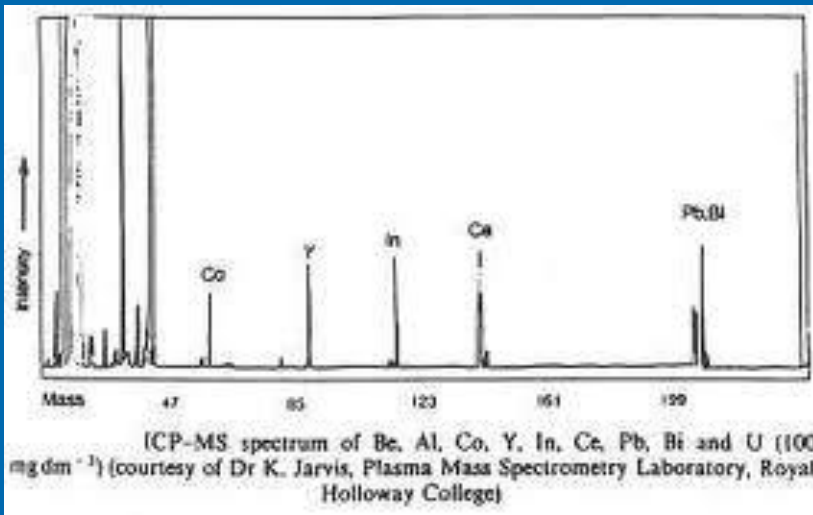

Capacidad de análisis del ICP-QMS



Interferencias en ICP-MS

Interferencias Isobáricas

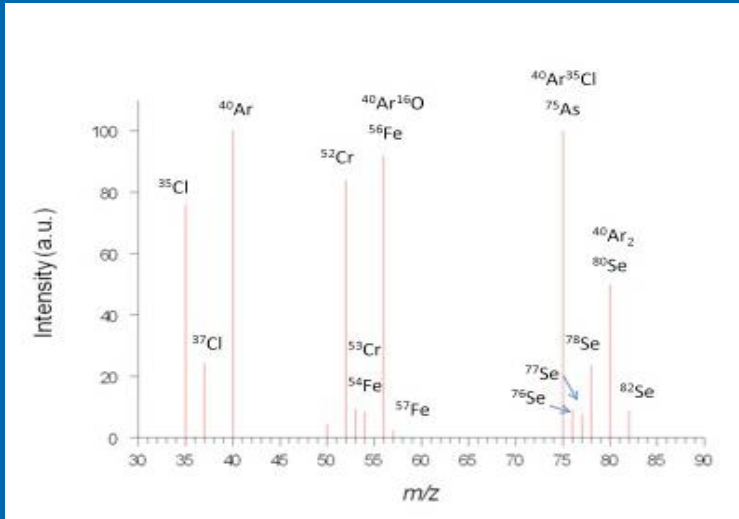

Interferencias poliatómicas

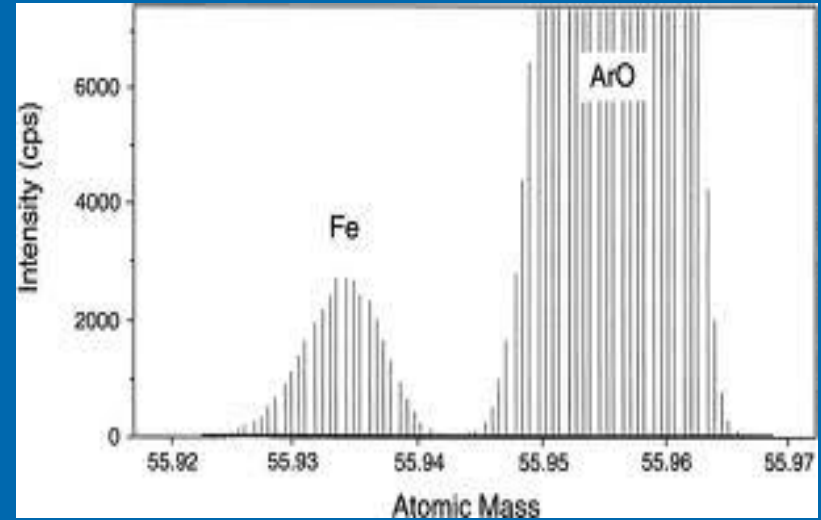

Ecuaciones de corrección de interferencias

$$^{75}\text{As} = 1 \times (^{75}\text{C}) - 3.127 \times (^{77}\text{C}) + 0.874 \times (^{82}\text{C})$$

$$I_{75,\text{corr}} = I_{75,\text{meas}} - \frac{X_{^{35}\text{Cl}}}{X_{^{37}\text{Cl}}} \left[I_{77,\text{meas}} - \left(\frac{X_{^{77}\text{Se}}}{X_{^{87}\text{Se}}} \right) [I_{82,\text{meas}} - \left(\frac{X_{^{87}\text{Kr}}}{X_{^{83}\text{Kr}}} \right) I_{83,\text{meas}}] \right] \quad [67]$$

Acoplamiento instrumental HPLC-ICPMS

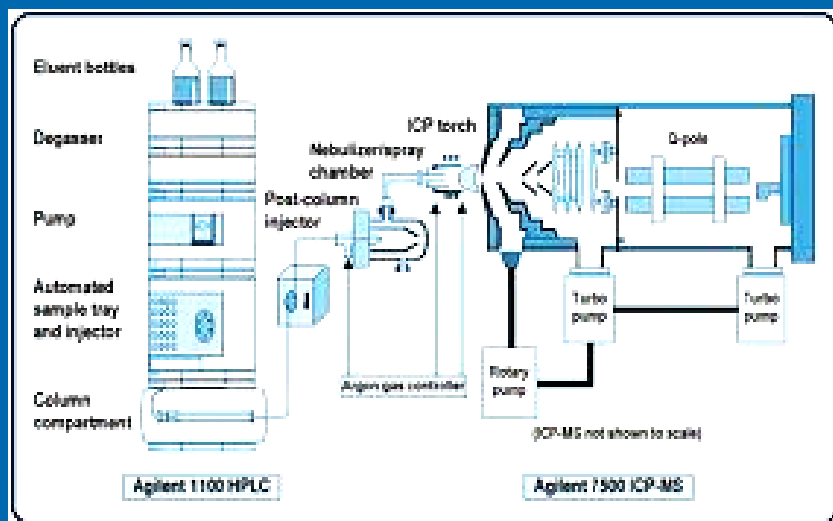

Especiación de Se

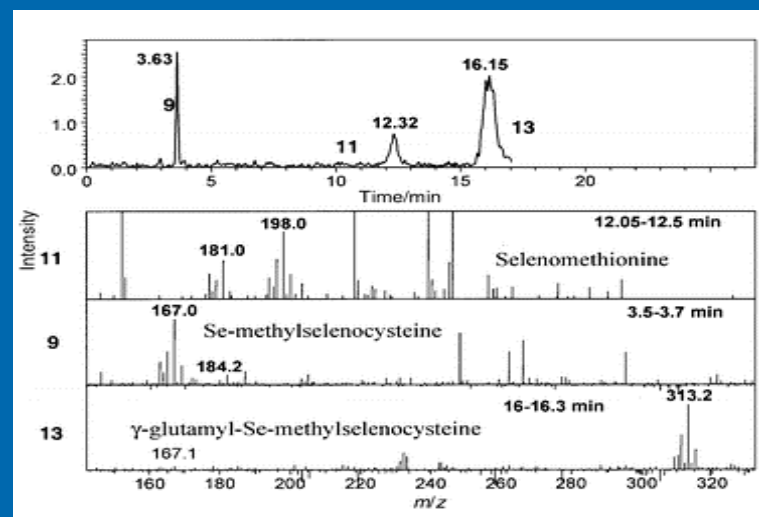

Especiación de As

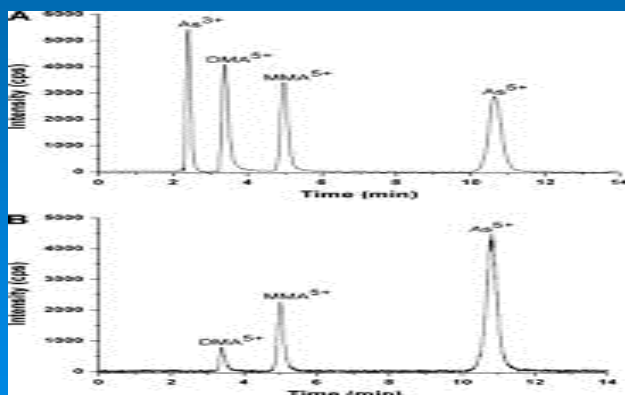

Especiación de Hg

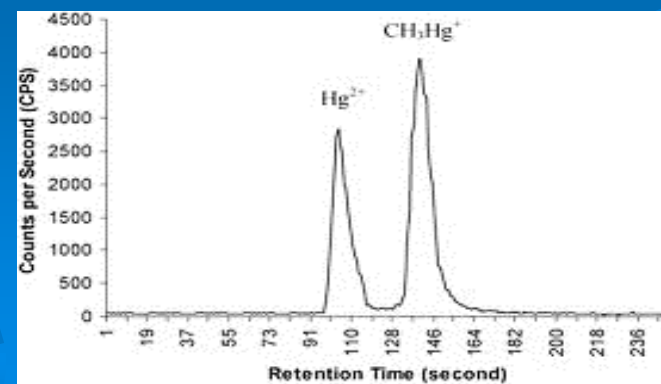

Medición Analítica

Calibración

Curva de calibración

Relación respuesta instrumental a estímulo. El resultado de una calibración es la relación entre las lecturas de un instrumento y los valores indicados por un patrón.

- Directa o estándar externo (con o sin igualación de matriz)
- Adición de estándar
- Estándar interno

Curva de calibración directa, o externa

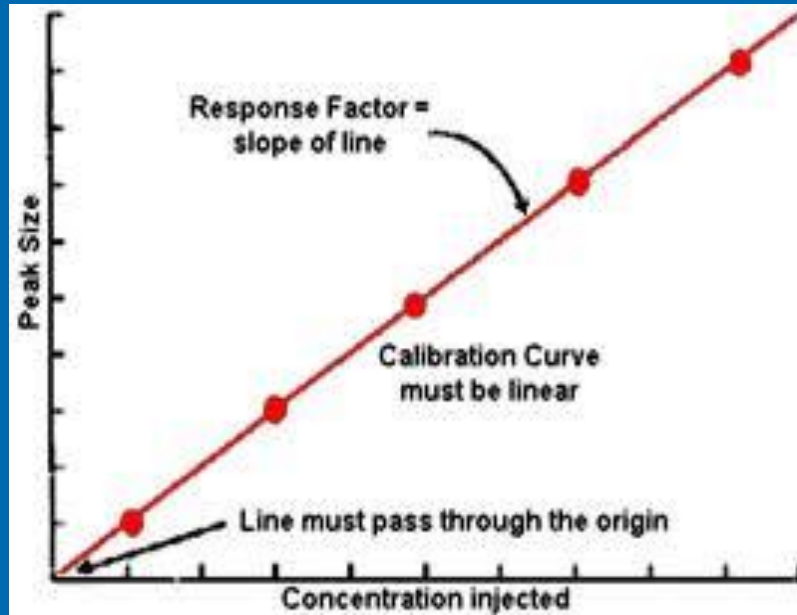

Curva de calibración por adición de estándar

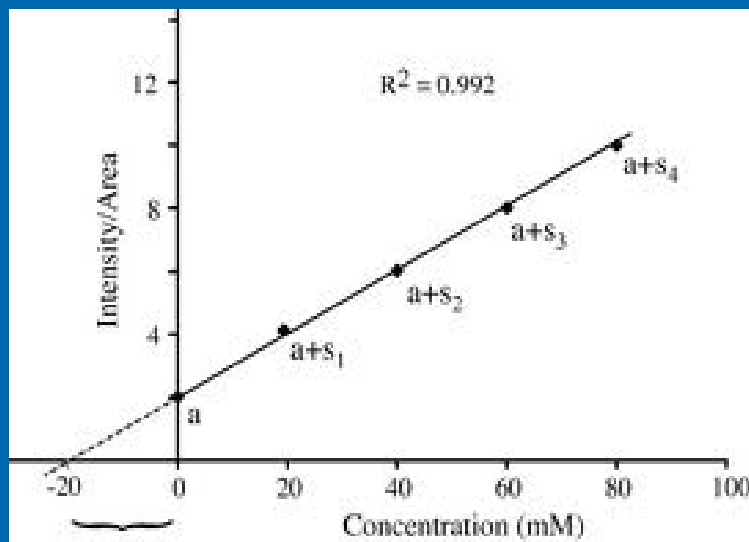

Curva de calibración por adición de estándar interno

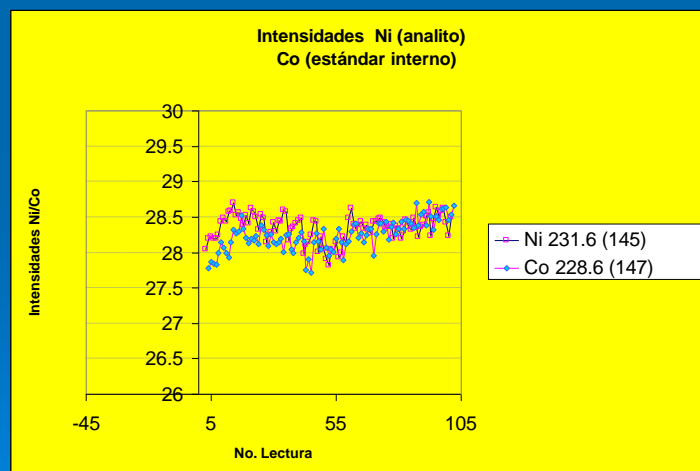
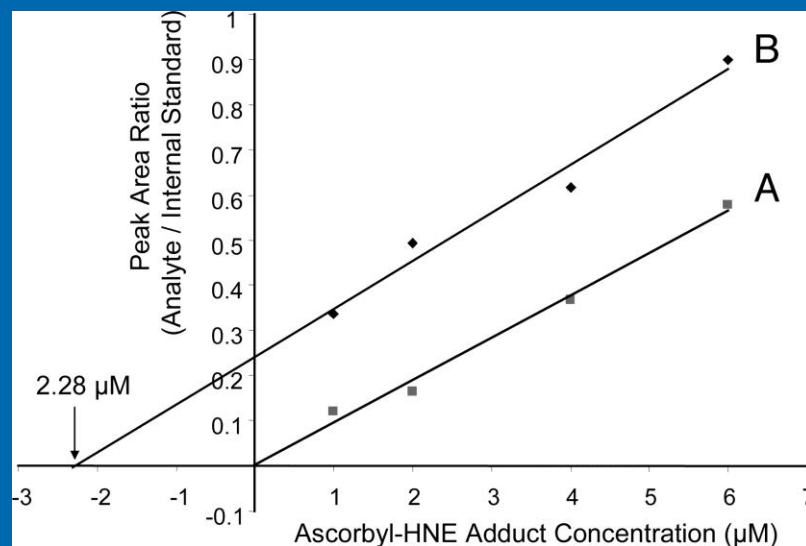

Validación de método de ensayo

- Exactitud
- Sensibilidad
- Límite de detección
- Límite de cuantificación
- Intervalo lineal
- Reproducibilidad
- Repetibilidad

Validación

Es la confirmación por examen y la provisión de evidencia objetiva de que se cumplen los requisitos particulares para un uso propuesto (método específico)

Validación de método

Es el proceso de establecer las características de desempeño y limitaciones de un método y la identificación de aquellas influencias que pueden modificar estas características y a que grado (analito, matriz, interferencia, incertidumbre)

Trazabilidad

Propiedad del resultado de una medición o del valor de un patrón, por el cual puede ser relacionado a referencias determinadas, generalmente patrones nacionales o internacionales, por medio de una cadena ininterrumpida de comparaciones, todas ellas teniendo incertidumbres determinadas.

Material de referencia

Material o sustancia, en la cual uno o mas valores de sus propiedades son suficientemente homogéneos y bien definidos, para ser utilizados para la calibración de aparatos, la evaluación de un método de medición, o para asignar valores a materiales

Material de referencia certificado

Material de referencia, acompañado de un certificado, en el cual uno o mas valores de las propiedades están certificados por un procedimiento que establece trazabilidad a una realización de la unidad en la cual se expresan los valores de la propiedad y en el que cada valor certificado se acompaña de una incertidumbre con el nivel declarado de confianza

Concentraciones totales certificadas en MRC 1573a (Hojas de tomate), NIST



National Institute of Standards & Technology

Certificate of Analysis

Standard Reference Material® 1573a

Tomato Leaves

This Standard Reference Material (SRM) is intended primarily for use in evaluating the reliability of analytical methods for the determination of major, minor, and trace elements in botanical materials, agricultural food products, and materials of similar matrix. A unit of SRM 1573a consists of 50 g of dried tomato leaves.

Certified and Noncertified Values of Constituent Elements: The certified values of the constituent elements are given in Table 1. These values are based on the agreement of results from at least two independent analytical methods or the mean of results from a method of known accuracy. Noncertified values of constituent elements are provided for information only in Table 2. All values are reported as mass fractions [1].

NOTICE AND WARNINGS TO USERS

Expiration of Certification: This certification is valid for five years from the date of shipment. Should any of the certified values change before the expiration of the certification, purchasers will be notified by NIST. Return of the attached registration card will facilitate notification.

Stability: This material was radiation sterilized at an estimated minimum dose of 25 kGy (2.5 Mrads) for microbiological control. However, its stability has not been rigorously assessed. NIST will monitor this material and will report any substantive changes to the purchaser.

Storage: The material should be kept tightly closed in its original bottle and stored in the dark at a temperature between 10 °C and 30 °C. It should not be exposed to intense sources of radiation. Ideally, the bottle should be kept in a desiccator under the conditions indicated above.

Use: The bottle contents should be thoroughly mixed by rotating and/or rolling the bottle before each use. Allow the contents to settle for one minute prior to opening. A minimum sample of 150 mg of (dry mass - see "Instructions for Drying"), should be used to relate analytical determinations to the certified values in this certificate. Volatile elements (e.g., arsenic, mercury, and selenium) should be determined on samples as received; separate samples from the same bottle should be dried according to these instructions to obtain a correction factor for moisture. This factor is then to be used to correct the analytical results to a dry mass basis.

Dissolution: Digestion procedures should be designed to avoid loss of volatile elements. Digestion of the SRM in nitric and perchloric acids was found to be incomplete with a small residue of siliceous material remaining. This residue must be considered an integral part of the SRM and should be treated with a small amount of hydrofluoric acid to obtain total dissolution.

Coordination of all analytical measurements used in the characterization of this SRM was performed by D.A. Becker of the NIST Analytical Chemistry Division formerly the Inorganic Analytical Research Division.

Statistical analysis of the experimental data was performed by W.F. Guthrie of the NIST Statistical Engineering Division.

The technical and support aspects involved in the certification and issuance of this SRM were coordinated through the Standard Reference Materials Program by R.A. Alvarez and T.E. Gills.

Gaithersburg, MD 20899
November 22, 1995
(Revision of certificate dated 10-19-93)

Thomas E. Gills, Chief
Standard Reference Materials Program

Page 1 of 5

MI

Instructions for Drying: Samples of this SRM must be dried only by one of the following two procedures.

1. Drying in a desiccator at room temperature (approximately 22 °C) for 120 h over fresh anhydrous magnesium perchlorate. The sample depth should not exceed 1 cm.

2. Freeze drying for 24 h at a pressure of 13.3 Pa or lower and a shelf temperature of -5 °C or lower after having frozen the sample (not to exceed 1 cm in depth) at -40 °C or lower for at least 1 h. At the end of the 24 h period, samples are placed immediately in a desiccator with fresh anhydrous magnesium perchlorate. Samples are weighed after allowing a minimum of 4 h to establish temperature equilibrium.

Note: Vacuum drying at room temperature and oven drying at elevated temperatures have resulted in excessive mass losses and therefore are not recommended.

Homogeneity Assessment: Homogeneity was assessed by careful evaluation of the analytical data used for certification. No evidence of chemically or statistically significant inhomogeneity was observed.

Table 1. Certified Mass Fractions (w_a)

Element	w_a (in %)
Calcium	5.05 ± 0.09
Nitrogen (Total)	3.03 ± 0.15
Phosphorus	0.216 ± 0.004
Potassium	2.70 ± 0.05

Element	w_a (in mg/kg)	Element	w_a (in mg/kg)
Aluminum	598 ± 12	Mercury	0.034 ± 0.004
Antimony	0.063 ± 0.006	Nickel	1.59 ± 0.07
Arsenic	0.112 ± 0.004	Plutonium	14.89 ± 0.27
Boron	33.3 ± 0.7	Selenium	0.054 ± 0.003
Cadmium	1.52 ± 0.04	Sodium	136 ± 4
Chromium	1.99 ± 0.06	Vanadium	0.835 ± 0.010
Cobalt	0.57 ± 0.02	Zinc	30.9 ± 0.7
Copper	4.70 ± 0.14		
Iron	368 ± 7		
Manganese	246 ± 8		

Certified Values and Uncertainties: The certified values are equally weighted means of results from two or more different analytical methods or the mean of results from a method of known accuracy. In the case of two or more methods, each uncertainty is the sum of a 95 % confidence limit and an allowance for systematic error between the methods used. In the case of a method of known accuracy, each uncertainty is the sum of a 95 % confidence limit and the known systematic error of the method.

Page 2 of 5

Exactitud

Proximidad de concordancia entre el resultado de una medición y un valor verdadero.

Recuperación

Proporción de la cantidad de analito, presente en la porción de la muestra o adicionado a esta, que es cuantificada por un método de ensayo.

Repetibilidad (de resultados de mediciones)

Proximidad de concordancia entre los resultados de mediciones sucesivas del mismo mensurando realizadas bajo las mismas condiciones de medición

Reproducibilidad

Proximidad de concordancia entre los resultados de mediciones del mismo mensurando realizadas bajo condiciones variables de medición

Intervalo lineal de respuesta

Relación lineal con la concentración del analito.

Límite de detección

La menor concentración del analito en una muestra que puede detectarse, pero no necesariamente cuantificarse bajo las condiciones establecidas de la prueba (instrumental y del método)

Límite de cuantificación

Es la concentración mas baja del analito que puede determinarse con un nivel de incertidumbre aceptable.

Sensibilidad

Cambio en la respuesta de un instrumento de medición dividido por el correspondiente cambio del estímulo.

$$S = \Delta Y / \Delta X$$

Incetidumbre

Parámetro, asociado al resultado de una medición, que caracteriza la dispersión de los valores que podrían ser razonablemente atribuidos al mensurando

Fuentes especializadas de consulta

Spectrochimica Acta, Part B, Atomic Spectroscopy (SPAB)

<http://www.journals.elsevier.com/spectrochimica-acta-part-b-atomic-spectroscopy/>

Journal of Analytical Atomic Spectrometry (JAAS)

<http://pubs.rsc.org/en/journals/journalissues/ja>

www.sciencedirect.com

International database for certified reference materials

<http://www.comar.bam.de/en/>

National Institute of Standards and Technology (NIST)

<http://www.nist.gov/>

Diseño experimental para determinación analítica de elementos traza, menores y/o mayores en alimentos

I. Selección de técnica analítica

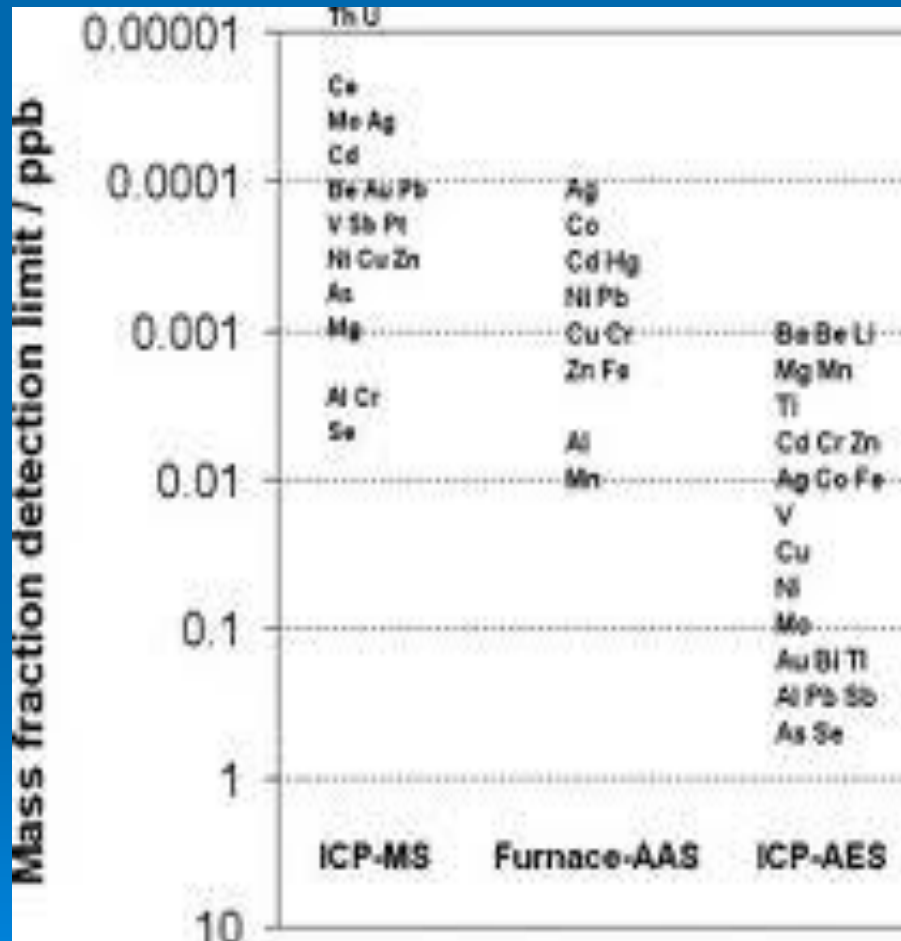

Comparación de LDI (Límites de Detección Instrumentales) de diversas técnicas analíticas espectrométricas

II. Muestreo de Alimentos diversos



III. Tratamiento Físico

1. Secado de la muestra



2. Molienda y homogeneización

mortero



molino

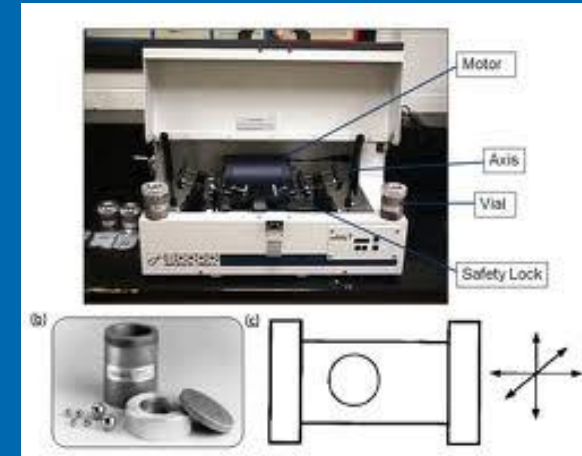

IV. Tratamiento químico

1. Pesada y adición de reactivos de digestión (HNO_3 , H_2O_2 , HCl , HF ; Kingston et al, 1997)



2. Filtración y aforación

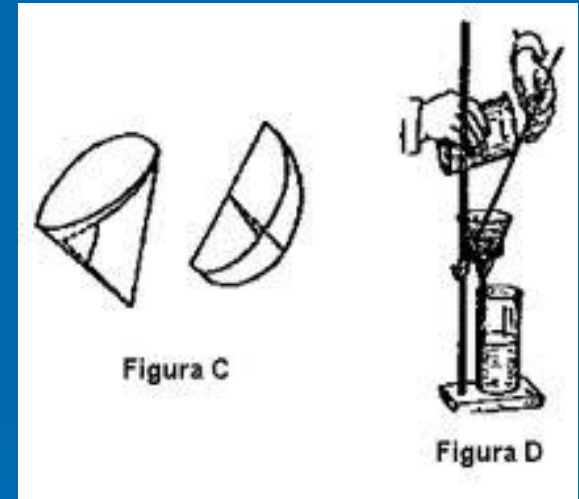

V. Análisis

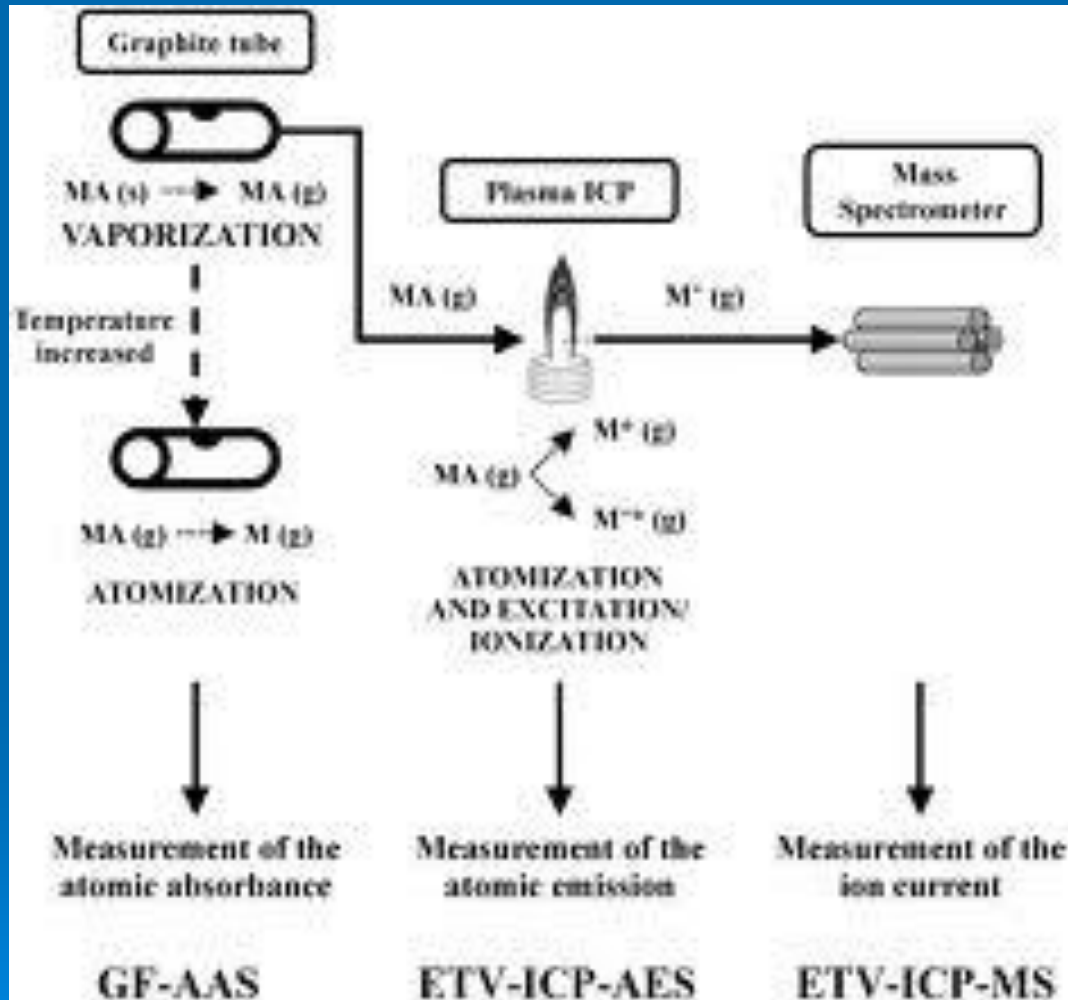

Principios de medición analítica de diversas técnicas analíticas espectrométricas

Ejemplos Prácticos





ELSEVIER

Contents lists available at ScienceDirect

Spectrochimica Acta Part B

journal homepage: www.elsevier.com/locate/sab

Review

Determination of As, Cd, Cu, Hg and Pb in biological samples by modern electrothermal atomic absorption spectrometry

Jordi Sardans ^{a,*}, Fernando Montes ^b, Josep Peñuelas ^a

^a Ecophysiological and Global Change Unit CSIC-CREAF, Edifici C, Universitat Autònoma de Barcelona, Bellaterra 08193, Barcelona, Spain

^b Departamento de Ciencias Analíticas, Facultad de Ciencias, Universidad Nacional de Educación a Distancia (UNED), C/ Senda del Rey 9, 28040 Madrid, Spain

Table 1

Different analytes, sample matrix types, sample treatments, modifiers and ETAAS spectrometers and background correction used in the determination by ETAAS of biological materials.

Analytes	Sample matrix	Sample pre-treatment	Modifiers	Background correction	Spectrometry characteristics and use	Ref.
Cd/Pb/Ni	Vegetable oils	Acid digestion HNO ₃ + H ₂ O ₂	(NH ₄) ₂ HPO ₄	Zeeman–Wetjet	Atomization at 1800 °C. Light line source	[1]
Cd	Mammal tissues	Acid digestion HNO ₃ + HCl		Deuterium lamp	Atomization at 1200 °C. Light line source. IFA	[2]
Cd/Cu/Pb	Fish tissues	Acid digestion HNO ₃ + HClO ₄		Zeeman	Line source	[3]
As/Cd/Co/Cu Fe/Ni/Pb/Zn	Plant tissues	Acid digestion HNO ₃	(NH ₄) ₂ HPO ₄ + Mg(NO ₃) ₂	Zeeman	Line source. Atomization at 2050 °C. Cd, 2300 °C. Cu, 1800 °C. Pb	[4]
Cd/Pb	Rice	Slurry and acid digestion HNO ₃	No word	Zeeman	Line source. Atomization at 1800 °C. Cd, 1700 °C. Pb	[5]
Cd/Cu/Mn/Ni	Baby food	Slurry and acid digestion HNO ₃ + HCl		Deuterium lamp	Line source. Atomization at 2000 °C. IFA	[6]
Cd/Co/Cu/Pb/Zn	Rawie milk	Acid digestion HNO ₃ + H ₂ O ₂	Mg(NO ₃) ₂ + NH ₄ H ₂ PO ₄ (Cd) FeCl ₃ + acid ascorbic (Cu, Pb)	Zeeman	Line source. Atomization at 1800 °C. Cd, 2300 °C. Cu, 1800 °C. Pb	[7]
Cd/Mn/Pb	Lichens and Mosses	Acid digestion HNO ₃				[8]
As/Cd/Co/Cu/Pb	Mosses	Acid digestion HNO ₃	Mg(NO ₃) ₂ + NH ₄ H ₂ PO ₄ (Cd) Mg(NO ₃) ₂ + Pd (As), Malonic Acid (Pb)		Line source	[9]
Cd/Pb	Mushrooms	Acid digestion HNO ₃ + H ₂ O ₂	NH ₄ H ₂ PO ₄ (Pb), Mg(NO ₃) ₂ + Pd (Cd)		Line source. Atomization at 1850 °C. Cd, 1800 °C. Pb	[10]
As/Co/Cu/Cd Fe/Ni/Pb	Mosses	Acid digestion HNO ₃			Line source. IFA	[11]
Cd/Pb	Lichens and mosses	Acid digestion HNO ₃		Deuterium lamp	Line source	[12]
Cd/Pb	Lichens	Acid digestion HNO ₃ + H ₂ O ₂	NH ₄ H ₂ PO ₄ + Mg(NO ₃) ₂ + Pd	Deuterium lamp	Line source. IFA	[13]
Cd	Plant tissues	Acid digestion HNO ₃ + HCl				[14]
Cd/Co/Ni/Pb/V	Plant tissues	Acid digestion HNO ₃		Zeeman	Line source	[15]
Cd/Pb	Animal and plant tissues	Acid digestion HNO ₃		Zeeman	Line source	[16]
Cd/Cu/Fe/Mn/Pb	Fish tissues	Dry ashing, acid digestion HNO ₃	(NH ₄) ₂ HPO ₄ + Mg(NO ₃) ₂		Line source. Atomization at 1800 °C. Cd, 2300 °C. Cu, 2000 °C. Pb	[17]
As	Fish and algae tissue	Leaching and CV in FIA	Zr + Ir coated in situ trapping + Pd mobile	Atomization at 2300 °C	Line source. THA	[18]
As/As/Cd/Co/Cd/Ni/Pb	Lichens, mosses and plant tissues	Acid digestion HNO ₃			Line source	[19]
Pb	Mushrooms	Dry ash and slurry		Zeeman	Line source	[21]
Cd	Mammal tissues	Acid digestion HNO ₃ + HCl			Line source	[22]
Cd/Fe/Mn	Mammal tissues	Acid digestion HNO ₃		Deuterium lamp	Line source. IFA	[23]
Hg	Urine	Acid digestion HNO ₃		Zeeman	Line source	[24]
As	Animal tissues	Acid digestion HNO ₃	Mg(NO ₃) ₂ + Pd, Ni(NO ₃) ₂ + H ₂ O ₂ + Pd. Cu(NO ₃) ₂ + H ₂ O + Pd	Zeeman	Line source. Atomization at 2300 °C.	[25]
As/Cd/Co/Ni/Pb/Zn	Fish tissues	Acid digestion HNO ₃			Line source	[26]
Cd/Pb	Animal and plant tissues	Acid digestion HNO ₃	(NH ₄) ₂ HPO ₄ + Mg(NO ₃) ₂	Zeeman	Line source	[27]
Cd/Cu/Pb	Animal and plant tissues	Acid digestion HNO ₃	Et ₃ N coated	Zeeman	Line source. THA	[28]
Cd/Ni/Mn	Algae	Acid digestion HNO ₃ and Slurry			Line source. Atomization at 1800 °C.	[29]
Pb	Plant tissues	Acid digestion HNO ₃		Deuterium lamp	Line source. Atomization at 2000 °C. IFA	[30]
Cd/Cu/Fe/Mn/Pb/Zn	Lichens	Acid digestion HNO ₃	Pd (Cd, Pb)		Light line source. Atomization at 1700 °C. Cd, 2000 °C. Cu, 1800 °C. Pb	[31]
Hg	Animal and plant tissues	Acid digestion HNO ₃ CV of line	Pd + Zr pre-treatment in situ trapping	Deuterium lamp	Line source. Atomization at 1800 °C.	[32]
Cd/Fe/Ni/Zn	Animal tissues	Acid digestion HNO ₃	Pd		Line source. Atomization at 2000 °C. IFA	[33]
Cd/Co/Cu/Ni/Pb	Animal tissues	Acid digestion HNO ₃		Deuterium lamp	Light line source. Atomization at 1800 °C. Cd, 2000 °C. Cu, 2300 °C. Pb	[34]
As	Animal and plant tissues	Acid digestion HNO ₃ Slurry. CV in FIA system	Ir pre-treatment in situ trapping	Deuterium lamp	Line source. Atomization at 2000 °C.	[35]
As/Cd/Pb	Urine	Acid digestion HNO ₃ FIA pre-treatment		Zeeman	Line source. Atomization at 1700 °C. THA	[36]
As	Plant tissues	Acid digestion HNO ₃ FIA CV ₂	Pd + Zr pre-treatment in situ trapping	Deuterium	Line source. Atomization at 2300 °C.	[37]
Cd/Co/Ni/Pb	Animal tissues	Acid digestion HNO ₃	Mg(NO ₃) ₂ + Pd		Line source. THA	[38]
Pb	Plant tissues	Acid digestion HNO ₃		Zeeman	Line source	[39]
Cd/Ni	Vegetable oils	Acid digestion HNO ₃		Zeeman	Line source. Atomization at 2000 °C. Cd, THA	[40]
Cd/Co/Co/Pb	Human blood	centrifugation + Acid digestion HNO ₃	NH ₄ H ₂ PO ₄ , Mg(NO ₃) ₂ , Pd(NO ₃) ₂	Zeeman	Line source. Atomization at 1800 °C. Cd,	[41]



Contents lists available at ScienceDirect

Spectrochimica Acta Part B

journal homepage: www.elsevier.com/locate/sab

Analytical note

Simultaneous determination of macronutrients, micronutrients and trace elements in mineral fertilizers by inductively coupled plasma optical emission spectrometry



Sidnei de Oliveira Souza ^a, Silvânio Silvério Lopes da Costa ^{a,b}, Dayane Melo Santos ^a, Jéssica dos Santos Pinto ^a, Carlos Alexandre Borges Garcia ^a, José do Patrocínio Hora Alves ^{a,c}, Rennan Geovanny Oliveira Araujo ^{a,d,*}

^a Laboratório de Química Analítica Ambiental (LQA), Departamento de Química, Centro de Ciências Exatas e Tecnologia, Universidade Federal de Sergipe (UFS), 49100-000, São Cristóvão, SE, Brazil

^b Coordenação de Química, Universidade Federal de Alagoas (UFAL), Campus Arapiraca, 57309-005, Arapiraca, AL, Brazil

^c Instituto Tecnológico e de Pesquisas do Estado de Sergipe (ITPS), 49000-000, Aracaju, SE, Brazil

^d Departamento de Química Analítica, Instituto de Química, Universidade Federal do Bahia (UFBA), 40170-215 Salvador, BA, Brazil

Table 1

Characteristics and operating conditions used for analysis by ICP OES with axial view.

Parameter	Characteristics	
Radio frequency power (W)	1200	
Plasma gas flow rate (L min ⁻¹)	15.0	
Auxiliary gas flow rate (L min ⁻¹)	1.5	
Sample uptake rate (mL min ⁻¹)	0.8	
Nebulizer gas flow rate (L min ⁻¹)	0.8	
Nebulizer type	Concentric, sea spray	
Spray chamber	Type cyclone	
Replicates	3	
Injector tube diameter (mm)	2.4	
Signal integration time (s)	1.0	
Wavelength (nm)	Al I 308.215	Mg II 280.265
	As I 188.980	Mn II 257.610
	Ca I 373.690	Na I 589.592
	Cd I 228.802	P I 213.618
	Cu I 327.595	Pb II 217.000
	Fe II 239.940	V II 292.403
	Mg I 285.213	Zn II 200.200

(I) Atomic line.

(II) Ionic line.

Table 3

Values obtained for BEC, LOD and LOQ in the analysis of mineral fertilizer samples by ICP OES.*

Analytical parameter	Al	As	Ca	Cd	Cu	Fe	Mg	Mn	Na	P	Pb	V	Zn
BEC (mg L ⁻¹)	0.05	0.1	0.2	0.004	0.004	0.02	0.02	0.001	0.03	0.05	0.006	0.002	0.01
LOD (mg kg ⁻¹)	5.4	5.0	21.5	3.3	3.0	14.3	6.3	0.6	14.0	23.2	3.0	1.2	5.0
LOQ (mg kg ⁻¹)	18.2	16.7	72.0	11.0	10.0	47.7	21.0	2.0	46.7	77.3	10.0	4.0	16.7

* Analytical parameters obtained for mass of 0.20 g of mineral fertilizers and completed to 25.0 mL with deionized water.

Table 5

Detection limits obtained by different techniques in the determination of macronutrients, micronutrients and trace elements in mineral fertilizers.

LOD	Al	As	Ca	Cd	Cu	Fe	Mg	Mn	Na	P	Pb	V	Zn	Technique	Reference
(mg kg ⁻¹)	-	4.82	-	0.77	-	-	-	-	-	-	1.35	-	-	ICP OES*	[4]
(mg kg ⁻¹)	-	-	-	0.24	0.00	-	-	0.62	-	-	2.39	-	1.15	FS FAAS ^b	[44]
(mg kg ⁻¹)	-	-	-	4.30	19.3	-	-	-	-	-	12.9	-	-	FAAS ^c	[45]
(mg kg ⁻¹)	-	-	-	-	0.44	0.82	-	0.30	-	-	-	-	0.30	MP AES ^d	[46]
(mg kg ⁻¹)	-	-	-	-	0.34	0.36	-	1.08	-	-	-	-	0.36	ICP OES ^e	[46]
(mg kg ⁻¹)	-	1.00	-	0.22	0.00	1.40	-	0.15	-	-	1.10	0.45	0.45	ICP OES ^f	[47]
(mg kg ⁻¹)	-	-	0.03	-	-	-	0.02	-	-	0.05	-	-	0.02	ICP-MS ^g	[48]
(mg kg ⁻¹)	5.40	5.00	21.5	3.30	3.00	14.3	6.30	0.60	14.0	23.2	3.00	1.20	5.00	ICP OES ^h	This study

ICP OES: inductively coupled plasma optical emission spectrometry//FAAS: Flame Atomic Absorption Spectrometry//FS FAAS: Fast Sequential Flame Atomic Absorption Spectrometry//MP AES: Microwave plasma atomic emission spectrometry//ICP-MS: Inductively coupled plasma mass spectrometry.

* Analytical parameters obtained using 1.00 g of mineral fertilizers in a final volume of 100 mL with deionized water.

^b Analytical parameters obtained using 0.12 g of organic fertilizers in a final volume of 10.0 mL with ultrapure water.

^c Analytical parameters obtained using 0.07 g of inorganic fertilizers in a final volume of 15.0 mL with deionized water.

^d Analytical parameters obtained using 1.00 g of animal feed and fertilizers in a final volume of 200 mL with deionized water.

^e Analytical parameters obtained using 1.00 g of mineral fertilizers in a final volume of 50.0 mL with double-distilled water.

^f Analytical parameters obtained using 0.40 g of mineral fertilizers in a final volume of 25.0 mL with deionized water.

^g Analytical parameters obtained using 0.20 g of mineral fertilizers in a final volume of 25.0 mL with deionized water.

^h Analytical parameters obtained using 0.20 g of mineral fertilizers in a final volume of 25.0 mL with deionized water.

$$\text{Recovery}(\%) = \left[\frac{\text{found value}}{\text{certified value}} \right] \times 100$$

Table 4
Results obtained for the SRM analysis by ICP OES using the proposed method.

SRM ^a	Parameters	Al ₂ O ₃ (%)	CdO (%)	Fe ₂ O ₃ (%)	MgO (%)	MnO (%)	Na ₂ O (%)	P ₂ O ₅ (%)						
NIST 094	Certified value	0.96 ± 0.05	0.013 ± 0.003	0.79 ± 0.06	0.33 ± 0.02	0.0116 ± 0.0012	0.86 ± 0.04	30.2 ± 0.1						
	Found value	0.84 ± 0.07	0.014 ± 0.001	0.66 ± 0.04	0.35 ± 0.04	0.0103 ± 0.0011	1.04 ± 0.06	25.9 ± 0.7						
	Recovery (%)	87.5 ± 3.0	93.3 ± 3.0	84.0 ± 3.0	106.0 ± 4.0	88.9 ± 3.0	120.0 ± 5.0	85.8 ± 3.0						
	RSD (%) ^b	3.0	3.0	4.0	4.0	3.0	3.0	3.0						
	Al (%)	As (mg kg ⁻¹)	Ca (%)	Cu (mg kg ⁻¹)	Cd (mg kg ⁻¹)	Fe (%)	Mg (%)	Mn (%)	Na (%)	P (%)	Pb (mg kg ⁻¹)	V (mg kg ⁻¹)	Zn (%)	
NIST 095	Certified value	0.61 ± 0.03	200 ± 5	2.26 ± 0.04	1125 ± 9	16.9 ± 0.2	3.99 ± 0.08	1.79 ± 0.05	0.305 ± 0.005	0.405 ± 0.005	7.2 ± 0.1	273 ± 17	122 ± 3	0.325 ± 0.005
	Found value	0.49 ± 0.01	179 ± 4	2.32 ± 0.05	1028 ± 16	14.0 ± 1.0	3.20 ± 0.05	1.50 ± 0.09	0.295 ± 0.009	0.430 ± 0.010	6.5 ± 0.2	250 ± 7	101 ± 2	0.280 ± 0.072
	Recovery (%)	80.0 ± 1.0	89.5 ± 1.0	102.6 ± 1.0	91.4 ± 1.0	82.8 ± 2.0	80.0 ± 1.0	83.8 ± 2.0	96.7 ± 1.0	106.2 ± 1.0	90.3 ± 1.0	91.6 ± 1.0	82.8 ± 1.0	80.0 ± 1.0
	RSD (%)	1.0	1.0	1.0	1.0	2.0	1.0	2.0	1.0	1.0	1.0	1.0	1.0	1.0
			Al ₂ O ₃ (%)		Fe ₂ O ₃ (%)		MgO (%)		P ₂ O ₅ (%)					
NIST 120C	Certified value			1.30 ± 0.04		1.08 ± 0.03		0.32 ± 0.01					33.34 ± 0.06	
	Found value			1.10 ± 0.03		0.92 ± 0.03		0.33 ± 0.01					28.46 ± 0.90	
	Recovery (%)			84.4 ± 3.0		85.5 ± 3.0		103.2 ± 3.0					85.4 ± 3.0	
	RSD (%)			3.0		3.0		3.0					3.0	

NIST 094: Western phosphate rock, NIST 095: Trace elements in multi-nutrient fertilizer and NIST 120C: Florida phosphate rock.

^a All results were expressed as mean ± 95% confidence interval (n = 3).

^b Relative standard deviation (RSD, n = 3).

JAAS



PAPER

[View Article Online](#)

[View Journal](#) | [View Issue](#)



Cite this: *J. Anal. At. Spectrom.*, 2018, **33**, 1354

Evaluation of an improved closed-vessel conductively heated digestion system for the analysis of raw meat samples by ICP techniques†

Alan Lima Vieira,^a Kelber Miranda,^b Alex Virgilio,^a Edilene Cristina Ferreira^a and José Anchieta Gomes Neto¹ *^a



Table 1 Instrumental operating conditions for ICP OES and ICP-MS/MS

Instrument parameter	Operating condition	
	ICP OES	ICP-MS/MS
RF applied power (kW)	1.15	1.55
Plasma gas flow rate (L min ⁻¹)	12	12
Auxiliary gas flow rate (L min ⁻¹)	0.5	1.09
Nebulizer gas flow (L min ⁻¹)	0.7	1.8
Nebulizer	Concentric	Concentric
Spray chamber	Cyclonic	Scott-type double-pass
Elements	λ (nm): C I 193.091; Ca I 422.673; Cu I 324.754; Fe II 238.204; K I 769.896; Mg I 285.213; Mn II 257.610; Na I 589.592; P I 178.284; S I 182.034; Zn I 213.856	⁷⁵ As, ¹¹⁴ Cd, ⁵² Cr, ⁹⁸ Mo, ²⁰⁸ Pb, and ⁸⁰ Se
Operating mode	Axial	Single quad MS/MS
Cell gas	—	none O ₂
O ₂ flow rate (mL min ⁻¹)	—	0 0.5
Analysis mode	—	On mass Mass-shift
Isotopes monitored	—	¹¹⁴ Cd and ²⁰⁸ Pb ⁷⁵ As ¹⁶ O, ⁵² Cr ¹⁶ O, ⁹⁸ Mo ¹⁶ O ₂ and ⁸⁰ Se ¹⁶ O
Atomic I and ionic II lines		

Table 5 Limits of quantitation (in mg kg⁻¹) for Ca, Cu, Fe, K, Mg, Mn, Na, P, S and Zn by ICP OES and As, Cd, Cr, Mo, Se and Pb by ICP-MS using digestion blanks for CHDS and MW

ICP OES elements	LOQ (mg kg ⁻¹)		ICP-MS elements	LOQ (mg kg ⁻¹)	LOQ (mg kg ⁻¹)
	CHDS	MW		CHDS	MW
Ca	3	2	As	0.0001	0.0003
Cu	1	0.5	Cd	0.0004	0.00006
Fe	3	1.5	Cr	0.0008	0.001
K	1.5	1.2	Mo	0.0003	0.0004
Mg	1	0.4	Se	0.003	0.004
Mn	0.5	0.1	Pb	0.001	0.002
Na	3	5			
P	5	4			
S	4.5	4			
Zn	1	1			

Table 2 Results (mean \pm standard deviation) for the determination ($n = 3$) of Ca, Cu, Fe, K, Mg, Mn, Na, P, S and Zn (in mg kg^{-1}) by ICP OES and As, Cd, Cr, Mo, Pb and Se (in mg kg^{-1}) by ICP-MS in CHDS digested CRMs^a

Element	186 pork kidney (mg kg^{-1})			1577b bovine liver (mg kg^{-1})			8414 bovine muscle (mg kg^{-1})		
	Certified	Determined	Rec (%)	Certified	Determined	Rec (%)	Certified	Determined	Rec (%)
ICP OES									
Cu	31.9 \pm 0.4	29.0 \pm 0.1	91	160 \pm 8	148 \pm 2	93	2.84 \pm 0.45	2.42 \pm 0.05	85
Fe	299 \pm 10	284 \pm 1	95	184 \pm 15	180 \pm 1	98	71.2 \pm 9.2	66 \pm 2	93
Mn	8.5 \pm 0.3	9.0 \pm 0.1	100	10.5 \pm 1.7	10.5 \pm 0.1	100	0.37 \pm 0.09	0.40 \pm 0.08	109
Zn	128 \pm 3	124 \pm 1	97	127 \pm 16	120 \pm 1	94	142 \pm 14	132 \pm 1	93
Ca	295 ^b	292 \pm 8	99	116 \pm 4	124 \pm 4	106	145 \pm 20	140 \pm 2	97
K	12 600 ^b	13 006 \pm 74	103	9940 \pm 20	9885 \pm 49	99	15 170 \pm 370	14 435 \pm 126	95
Mg	829 ^b	858 \pm 20	104	601 \pm 28	600 \pm 5	100	960 \pm 95	936 \pm 12	98
Na	7100 ^b	7279 \pm 55	103	2420 \pm 60	2245 \pm 17	93	2100 \pm 80	1960 \pm 20	93
S	NC	8552 \pm 6	—	7850 \pm 60	7505 \pm 75	96	7950 \pm 410	7405 \pm 74	93
P	12 200 ^b	11 920 \pm 170	98	11 000 \pm 300	11 682 \pm 219	106	8360 \pm 450	8145 \pm 136	97
ICP-MS									
As	0.063 \pm 0.009	0.058 \pm 0.003	92	0.05 ^b	0.046 \pm 0.003	92	0.009 \pm 0.003	0.097 \pm 0.0003	108
Cd	2.71 \pm 0.15	2.58 \pm 0.07	95	0.50 \pm 0.03	0.46 \pm 0.02	92	0.013 \pm 0.011	0.013 \pm 0.001	100
Cr	NC	0.058 \pm 0.004	—	NC	0.22 \pm 0.01	—	0.071 \pm 0.038	0.074 \pm 0.003	104
Mo	NC	3.2 \pm 0.1	—	3.5 \pm 0.3	3.7 \pm 0.1	106	0.08 \pm 0.06	0.073 \pm 0.003	91
Pb	0.306 \pm 0.011	0.31 \pm 0.01	101	0.129 \pm 0.004	0.133 \pm 0.005	103	0.38 \pm 0.24	0.36 \pm 0.01	95
Se	10.3 \pm 0.5	10.2 \pm 0.3	99	0.73 \pm 0.06	0.80 \pm 0.03	110	0.076 \pm 0.010	0.078 \pm 0.002	103

^a NC = non-certified. ^b Reference values.

Table 3 Results (average \pm standard deviation) for the determination ($n = 3$) of macro and micronutrients (in mg kg^{-1}) in raw meat samples by ICP OES after CHDS and MW digestion. Analyzed samples were: beef (BM), pork (PM) and chicken (CM) muscles, beef (BL), pork (PL) and chicken (CL) livers and beef (BK) and pork (PK) kidneys

Samples		Elements (mg kg^{-1})									
		Ca	K	Mg	Na	S	P	Fe	Cu	Mn	Zn
BM	MW	54 \pm 5	3566 \pm 193	262 \pm 10	512 \pm 16	2174 \pm 83	2181 \pm 62	20.6 \pm 0.5	<0.5	<0.10	27.9 \pm 0.7
	CHDS	56 \pm 5	3432 \pm 25	250 \pm 3	514 \pm 3	2253 \pm 31	2216 \pm 11	19.5 \pm 0.4	<1	<0.17	28.8 \pm 0.7
PM	MW	63 \pm 1	3845 \pm 144	238 \pm 9	578 \pm 15	1879 \pm 92	2304 \pm 76	5.3 \pm 0.2	<0.5	<0.10	15.1 \pm 0.9
	CHDS	59 \pm 2	3763 \pm 62	230 \pm 4	587 \pm 3	1921 \pm 31	2337 \pm 64	5.6 \pm 0.1	<1	<0.17	15.3 \pm 0.1
CM	MW	46 \pm 1	3448 \pm 48	329 \pm 3	297 \pm 4	2090 \pm 6	2498 \pm 15	2.41 \pm 0.06	<0.5	<0.10	6.17 \pm 0.04
	CHDS	45 \pm 2	3568 \pm 22	328 \pm 1	309 \pm 1	2164 \pm 11	2667 \pm 17	<3	<1	<0.17	6.2 \pm 0.3
BL	MW	61 \pm 4	3150 \pm 10	187 \pm 1	655 \pm 5	2290 \pm 12	3654 \pm 46	81.1 \pm 0.8	73.8 \pm 0.7	2.75 \pm 0.02	34.6 \pm 0.1
	CHDS	58 \pm 6	3140 \pm 24	176 \pm 2	642 \pm 7	2250 \pm 26	3612 \pm 136	80.6 \pm 0.4	70.5 \pm 0.5	2.70 \pm 0.01	33.8 \pm 0.3
PL	MW	63 \pm 1	2839 \pm 1	188 \pm 1	699 \pm 7	2257 \pm 12	3503 \pm 32	59.1 \pm 0.4	6.2 \pm 0.2	3.92 \pm 0.05	45.2 \pm 0.1
	CHDS	64 \pm 7	2903 \pm 20	180 \pm 4	705 \pm 6	2293 \pm 8	3727 \pm 46	60.6 \pm 0.9	5.93 \pm 0.09	3.91 \pm 0.06	45.6 \pm 0.4
CL	MW	57.0 \pm 0.3	2275 \pm 15	188 \pm 1	604 \pm 6	1830 \pm 14	2939 \pm 63	104 \pm 1	3.11 \pm 0.07	2.20 \pm 0.03	28.8 \pm 0.2
	CHDS	55.2 \pm 0.9	2380 \pm 10	192 \pm 3	638 \pm 2	1880 \pm 5	3031 \pm 25	104.6 \pm 0.3	3.07 \pm 0.04	2.26 \pm 0.02	29.1 \pm 0.1
BK	MW	123 \pm 4	2317 \pm 13	178 \pm 1	1976 \pm 29	1890 \pm 16	2883 \pm 28	64.6 \pm 0.6	3.4 \pm 0.1	1.01 \pm 0.02	21.8 \pm 0.1
	CHDS	123 \pm 5	2396 \pm 20	173 \pm 1	2031 \pm 19	1903 \pm 10	2841 \pm 22	67.4 \pm 0.8	3.16 \pm 0.05	1.10 \pm 0.01	21.9 \pm 0.2
PK	MW	96 \pm 2	2513 \pm 46	187 \pm 3	1443 \pm 23	1871 \pm 34	3023 \pm 56	47 \pm 1	6.6 \pm 0.1	1.82 \pm 0.05	26.1 \pm 0.5
	CHDS	96 \pm 3	2594 \pm 27	184 \pm 4	1455 \pm 18	1872 \pm 6	2899 \pm 33	50.3 \pm 0.7	6.5 \pm 0.2	1.68 \pm 0.04	26.2 \pm 0.1

Table 4 Results (average \pm standard deviation) for the determination ($n = 3$) of micro and toxic elements (in mg kg^{-1}) in raw meat samples by ICP-MS after CHDS and MW digestion. Analyzed samples were: beef (BM), pork (PM) and chicken (CM) muscles, beef (BL), pork (PL) and chicken (CL) livers and beef (BK) and pork (PK) kidneys

Sample		Elements (mg kg^{-1})					
		As	Cd	Cr	Mo	Pb	Se
BM	MW	0.0025 ± 0.0001	<0.00006	0.029 ± 0.002	0.0051 ± 0.0001	<0.002	0.044 ± 0.003
	CHDS	0.0028 ± 0.0002	<0.0004	0.026 ± 0.001	0.00493 ± 0.00007	<0.001	0.0430 ± 0.0007
PM	MW	0.00098 ± 0.00008	<0.00006	0.025 ± 0.002	0.01157 ± 0.00003	<0.002	0.076 ± 0.005
	CHDS	0.00111 ± 0.00003	<0.0004	0.022 ± 0.001	0.0120 ± 0.0003	<0.001	0.074 ± 0.002
CM	MW	0.00088 ± 0.00006	<0.00006	0.014 ± 0.001	0.0271 ± 0.0008	<0.002	0.060 ± 0.001
	CHDS	0.00100 ± 0.00006	<0.0004	0.013 ± 0.001	0.029 ± 0.001	<0.001	0.063 ± 0.004
BL	MW	0.00197 ± 0.00007	0.0030 ± 0.0003	0.0090 ± 0.0005	0.76 ± 0.04	0.0049 ± 0.0002	0.167 ± 0.004
	CHDS	0.0023 ± 0.0002	0.0034 ± 0.0002	0.0099 ± 0.0003	0.81 ± 0.01	0.0056 ± 0.0004	0.163 ± 0.001
PL	MW	0.0012 ± 0.0001	0.00155 ± 0.00006	0.0041 ± 0.0003	1.09 ± 0.01	<0.002	0.41 ± 0.01
	CHDS	0.00129 ± 0.00004	0.00172 ± 0.00009	0.0038 ± 0.0003	1.14 ± 0.04	<0.001	0.38 ± 0.02
CL	MW	0.0014 ± 0.0001	<0.00006	0.0158 ± 0.0004	0.662 ± 0.006	0.0025 ± 0.0002	0.41 ± 0.02
	CHDS	0.00148 ± 0.00006	<0.0004	0.0173 ± 0.0009	0.668 ± 0.009	0.0030 ± 0.0003	0.381 ± 0.008
BK	MW	0.0076 ± 0.0002	0.0480 ± 0.0009	<0.001	0.343 ± 0.008	0.013 ± 0.005	1.09 ± 0.04
	CHDS	0.0083 ± 0.0004	0.0495 ± 0.0008	<0.0008	0.356 ± 0.006	0.011 ± 0.002	1.03 ± 0.04
PK	MW	0.0028 ± 0.0002	0.0228 ± 0.0002	0.011 ± 0.001	0.705 ± 0.001	0.0125 ± 0.0003	1.5 ± 0.1
	CHDS	0.00304 ± 0.00006	0.0240 ± 0.0008	0.0123 ± 0.0007	0.73 ± 0.02	0.0134 ± 0.0005	1.41 ± 0.03

JAAS



PAPER

[View Article Online](#)

[View Journal](#) | [View Issue](#)



Cite this: *J. Anal. At. Spectrom.*, 2019, 34, 674

Determination of trace elements in undiluted wine samples using an automatized total sample consumption system coupled to ICP-MS†

Claudia Cerutti,^a Carlos Sánchez,^b Raquel Sánchez,^{b*} Francisco Ardini,^a Marco Grotti,^a and José-Luis Todoli^b

Table 1 ICP-MS operating conditions

Sample introduction system (hTISIS)	
Liquid flow rate/ $\mu\text{L min}^{-1}$	20–50
Temperature/ $^{\circ}\text{C}$	50–300
Nebulizer gas flow rate/ L min^{-1}	0.4
Ar HMI flow rate/ L min^{-1}	0.56
Plasma	
Plasma gas flow rate/ L min^{-1}	15.0
Auxiliary gas flow rate/ L min^{-1}	1.0
RF Power/W	1600
Collision cell	
He flow rate/ mL min^{-1}	4.3
OctP Bias/V	–18
Oct RF/V	200
Energy discrimination/V	3.0
Acquisition parameters	
Number of replicates	5
Integration time/s	0.3
Sweeps per replicate	100
Measured ions	
Analytes	$^{47}\text{Ti}^+$, $^{51}\text{V}^+$, $^{52}\text{Cr}^+$, $^{55}\text{Mn}^+$, $^{56}\text{Fe}^+$, $^{60}\text{Ni}^+$, $^{63}\text{Cu}^+$, $^{66}\text{Zn}^+$, $^{75}\text{As}^+$, $^{95}\text{Mo}^+$, $^{111}\text{Cd}^+$, $^{146}\text{Nd}^+$, $^{147}\text{Sm}^+$, $^{157}\text{Gd}^+$, $^{159}\text{Tb}^+$, $^{208}\text{Pb}^+$
Internal standards	$^{72}\text{Ge}^+$, $^{103}\text{Rh}^+$, $^{185}\text{Re}^+$
Diagnostics	$^{140}\text{Ce}^+$, $^{140}\text{Ce}^{++}$, $^{140}\text{Ce}^{16}\text{O}^+$

Table 4 Detection limits of the developed method, the reference method based on microwave-assisted acid digestion and other ICP-based published methods (values in $\mu\text{g kg}^{-1}$)

	hTISIS method	Reference method ^a	Ref. 39	Ref. 40	Ref. 36	Ref. 37
Dilution factor	Undiluted	14	3	3	10	10
^{47}Ti	0.4	1.4	1.6	0.7	0.16	5
^{51}V	0.015	0.5	0.07	0.03	0.12	0.7
^{52}Cr	0.14	0.5	0.2	0.7	15	
^{55}Mn	0.17	0.5	0.07	0.2	0.7	
^{56}Fe	4	25				
^{60}Ni	0.16	0.6	1.0	0.3	3	1.0
^{63}Cu	0.18	1.0	0.07	0.15	0.8	10
^{66}Zn	3	0.5	0.05	0.8	2	
^{75}As	0.05	0.6	0.02	0.04		3
^{95}Mo	0.13	1.3	0.09	0.2		
^{111}Cd	0.03	0.13	0.03	0.02		
^{146}Nd	0.007	0.1		0.006		1.2
^{147}Sm	0.002	0.08	0.006	0.006		
^{157}Gd	0.002	0.02	0.003	0.003		0.9
^{159}Tb	0.002	0.017				
^{208}Pb	0.02	0.15	0.015	0.02	0.12	0.6

^a Microwave-assisted acid digestion and ICP-MS analysis using a conventional sample introduction system.

Table 3 Concentrations found for three wine samples using the reference microwave assisted digestion method, the conventional liquid sample introduction system and the hTISIS (mean \pm 95%-confidence interval; values in $\mu\text{g kg}^{-1}$)^a

	Tempranillo 2			Gutturnio			Rioja		
	MW digestion	Conventional	hTISIS 125 °C	MW digestion	Conventional	hTISIS 125 °C	MW digestion	Conventional	hTISIS 125 °C
Ti	29.7 \pm 8.5	30.3 \pm 2.9	44.2 \pm 2.3	39.07 \pm 0.13	43.7 \pm 1.8	37.4 \pm 1.8	52 \pm 47	84.3 \pm 9.1	46.4 \pm 2.8
V	<1.5	0.305 \pm 0.024	1.467 \pm 0.090	<1.5	ND	0.646 \pm 0.076	<1.5	0.195 \pm 0.049	1.15 \pm 0.10
Cr	15.7 \pm 3.8	11.71 \pm 0.21	19.4 \pm 1.0	6 \pm 19	5.64 \pm 0.11	4.87 \pm 0.25	4 \pm 6	5.41 \pm 0.27	3.25 \pm 0.17
Mn	1704 \pm 42	1019 \pm 20	1723 \pm 100	1521 \pm 79	1328 \pm 32	1442 \pm 71	740.7 \pm 5.5	858 \pm 40	667 \pm 40
Fe	3320 \pm 230	2018 \pm 43	3460 \pm 190	1580 \pm 830	959.1 \pm 9.0	1229 \pm 48	1180 \pm 400	1421 \pm 64	1213 \pm 35
Ni	83 \pm 34	12.32 \pm 0.51	75.4 \pm 3.2	192.1 \pm 6.4	44.1 \pm 1.2	211.4 \pm 8.2	89 \pm 15	22.96 \pm 0.96	78.7 \pm 2.3
Cu	261 \pm 29	78.9 \pm 1.4	242 \pm 10	983 \pm 25	109.5 \pm 3.6	215.0 \pm 7.6	91 \pm 12	74.9 \pm 2.4	105.9 \pm 1.8
Zn	290 \pm 79	542 \pm 15	258 \pm 12	130 \pm 110	549 \pm 17	144.3 \pm 5.0	241 \pm 70	981 \pm 50	216.7 \pm 6.4
As	3.0 \pm 1.1	0.919 \pm 0.050	4.21 \pm 0.23	2.9 \pm 2.8	0.60 \pm 0.14	2.86 \pm 0.21	16.3 \pm 3.2	1.32 \pm 0.11	3.25 \pm 0.20
Mo	18.1 \pm 3.5	4.2 \pm 1.1	19.3 \pm 1.3	13.7 \pm 1.1	1.42 \pm 0.40	13.71 \pm 0.48	17.4 \pm 2.0	9.04 \pm 0.30	15.61 \pm 0.80
Cd	<0.4	ND	0.390 \pm 0.043	<0.4	ND	0.462 \pm 0.031	<0.4	0.0261 \pm 0.0033	0.391 \pm 0.024
Nd	<0.3	ND	<0.02	<0.3	0.043 \pm 0.015	0.0257 \pm 0.0042	<0.3	0.120 \pm 0.018	0.246 \pm 0.052
Sm	<0.2	0.040 \pm 0.016	0.034 \pm 0.014	<0.2	0.045 \pm 0.028	0.0716 \pm 0.0055	<0.2	0.057 \pm 0.014	0.2627 \pm 0.0093
Gd	<0.06	0.034 \pm 0.018	0.0072 \pm 0.0018	<0.06	0.0414 \pm 0.0091	0.0100 \pm 0.0018	<0.06	0.0573 \pm 0.0068	0.0511 \pm 0.0034
Tb	<0.03	0.031 \pm 0.033	0.0444 \pm 0.0065	<0.03	0.031 \pm 0.014	0.0113 \pm 0.0012	<0.03	0.036 \pm 0.013	0.0946 \pm 0.0054
Pb	13.50 \pm 0.49	6.12 \pm 0.11	12.20 \pm 0.60	4.83 \pm 0.96	3.08 \pm 0.65	5.87 \pm 0.32	23.2 \pm 6.9	11.87 \pm 0.35	18.21 \pm 0.48

^a ND: not detected.

Table 5 Trace element concentrations in wine samples (mean \pm 95%-confidence interval)

Analyte	Gutturnio (Italy)	Malvasia (Italy)	Ortrugo (Italy)	Cabernet S. (Italy)	Cortese (Italy)	Monastrell (Spain)	Tempranillo 1 (Spain)	Tempranillo 2 (Spain)	Rioja (Spain)	Alicante (Spain)
Ti	37 \pm 2	73 \pm 4	125 \pm 2	138 \pm 12	93 \pm 4	88 \pm 5	88 \pm 8	44 \pm 2	46 \pm 3	80 \pm 2
V	0.65 \pm 0.08	12.1 \pm 0.8	12.0 \pm 0.7	18 \pm 3	45.2 \pm 0.6	12.9 \pm 0.7	12 \pm 1	1.47 \pm 0.09	1.2 \pm 0.1	20.7 \pm 0.5
Cr	4.9 \pm 0.2	36 \pm 1	80 \pm 1	32 \pm 1	26.7 \pm 0.8	28 \pm 2	27 \pm 2	19 \pm 1	3.3 \pm 0.2	25.7 \pm 0.8
Mn	1442 \pm 71	1182 \pm 40	1496 \pm 16	1102 \pm 173	412 \pm 10	933 \pm 54	988 \pm 63	1723 \pm 100	667 \pm 40	779 \pm 20
Fe	1229 \pm 48	714 \pm 42	701 \pm 12	2421 \pm 384	440 \pm 9	1423 \pm 99	1280 \pm 96	3457 \pm 186	1213 \pm 35	1158 \pm 26
Ni	211 \pm 8	44 \pm 1	61.4 \pm 0.8	42 \pm 1	29.6 \pm 0.6	28 \pm 2	30.2 \pm 0.9	75 \pm 3	79 \pm 2	25.7 \pm 0.7
Cu	215 \pm 8	182 \pm 7	1954 \pm 68	268 \pm 28	214 \pm 10	102 \pm 6	89 \pm 14	242 \pm 10	106 \pm 2	29 \pm 2
Zn	144 \pm 5	685 \pm 32	2505 \pm 77	158 \pm 9	266 \pm 9	585 \pm 35	523 \pm 84	258 \pm 12	216 \pm 6	601 \pm 17
As	2.9 \pm 0.2	3.8 \pm 0.2	4.0 \pm 0.2	3.5 \pm 0.6	3.3 \pm 0.1	2.9 \pm 0.2	2.5 \pm 0.4	4.2 \pm 0.2	3.3 \pm 0.2	2.4 \pm 0.1
Mo	13.7 \pm 0.5	17 \pm 3	25 \pm 2	25 \pm 3	42 \pm 1	60 \pm 6	32 \pm 2	19.3 \pm 1.3	15.6 \pm 0.8	24.4 \pm 0.5
Cd	0.46 \pm 0.03	0.32 \pm 0.02	<0.03	<0.03	0.14 \pm 0.02	<0.03	<0.03	0.39 \pm 0.04	0.39 \pm 0.02	<0.03
Nd	0.026 \pm 0.004	0.13 \pm 0.02	0.09 \pm 0.01	1.6 \pm 0.2	2.8 \pm 0.8	0.09 \pm 0.02	0.057 \pm 0.009	<0.02	0.25 \pm 0.05	0.16 \pm 0.03
Sm	0.072 \pm 0.006	0.11 \pm 0.02	0.059 \pm 0.007	0.39 \pm 0.06	0.64 \pm 0.04	0.09 \pm 0.02	0.050 \pm 0.009	0.03 \pm 0.01	0.263 \pm 0.009	0.062 \pm 0.009
Gd	0.010 \pm 0.002	0.36 \pm 0.05	0.08 \pm 0.01	0.37 \pm 0.06	0.59 \pm 0.3	0.10 \pm 0.01	0.05 \pm 0.01	0.007 \pm 0.002	0.051 \pm 0.003	0.11 \pm 0.01
Tb	0.011 \pm 0.001	0.10 \pm 0.01	0.042 \pm 0.005	0.09 \pm 0.01	0.15 \pm 0.02	0.07 \pm 0.01	0.038 \pm 0.008	0.044 \pm 0.007	0.095 \pm 0.005	0.038 \pm 0.004
Pb	5.8 \pm 0.3	19 \pm 2	13.9 \pm 0.9	35 \pm 3	9.4 \pm 0.4	37 \pm 2	10.9 \pm 0.2	12.2 \pm 0.6	18.2 \pm 0.5	17 \pm 1

Bibliografía

- Adriano, D. C. (2001). Trace elements in terrestrial environments. Biogeochemistry, bioavailability, and risk of metals. 2a. ed. Ed. Springer, USA
- Alvarado, S. & Leyva, C. (2005). Oferta, demanda, balanza comercial y competitividad del pescado de México en el mundo. Universidad Autónoma de Yucatán, México
- Amalia Z. Berna, A.Z., et al (2009). Geographical origin of Sauvignon Blanc wines predicted by mass spectrometry and metal oxide based electronic nose. Review. *Analytica Chimica Acta* 648, 146–152
- Celik, U., et al (2004) Determination of the lead and cadmium burden in Some Northeastern Atlantic and Mediterranean Fish Species by DPSAV. *Eur. Food Res. Technol.* 218, 298–305.
- Christopher, S.J., et al (2005). Improved calibration strategy for measurement of trace elements in biological and clinical whole blood reference materials via collision-cell inductively coupled plasma mass spectrometry. *J. Anal. At. Spectrom.* 20, 1035-1043
- Eurachem (1998). The fitness for purpose of analytical methods, A laboratory guide to method validation and related topics. Guide, EUA
- Zhao, F.J. et al. (2010). Arsenic as a Food Chain Contaminant: Mechanisms of Plant Uptake and Metabolism and Mitigation Strategies. *Annu. Rev. Plant Biol.* 61, 535-559
- Gehle, K., et al. *La toxicidad del arsénico*. Agencia para Sustancias Tóxicas y el Registro de Enfermedades (ATSDR). Estudios de Caso en Medicina Ambiental (CSEM), EUA, 2009
http://www.atsdr.cdc.gov/es/csem/arsenic/docs/Arsenic_CSEM_Spanish.pdf
- Goldaracena C. (2007). *Metales pesados en organismos acuáticos en dos lagunas costeras del Sur de Tamaulipas y Norte de Veracruz*, Tesis del Instituto Politécnico Nacional, México

- Jugdeep Aggarwal, J. et al (2008). Application of heavy stable isotopes in forensic isotope geochemistry. *Applied Geochemistry* 23, 2658–2666
- Kelly, S., et al (2005). Tracing the geographical origin of food: The application of multi-element and multi-isotope analysis. *Trends in Food Science & Technology* 16, 555–567
- Kingston, H.M. et al. Microwave-enhanced chemistry. Fundamentals, sample preparation and applications. Ed. American Chemical Society, USA, 1997
- Martinez, I., et al (2003). Destructive and non-destructive analytical techniques for authentication and composition analyses of foodstuffs. *Trends in Food Science & Technology* 14, 489–498
- Medeiros R. & dos Santos L. (2012). Determination of inorganic trace elements in edible marine fish from Rio de Janeiro State, Brazil, *Food Control* 23, 535-541.
- Özkan, Ö. (2010). Seasonal differences in the trace metal and macrominerals in shrimp (*Paranaus longirostris*) from Marmara Sea. *Environ Monit Assess*, 162, 191-199
- Procuraduría Federal de Protección al Ambiente-PROFECO (2010). Sondeo sobre hábitos de consumo de pescados y mariscos en cuaresma y semana santa. México
- Rodríguez S., M.T.J. (2007). Geoquímica de metales pesados en suelos superficiales. Unidad Teórica B. Instituto de Geofísica, Posgrado en Ciencias de la Tierra, UNAM
- Ruzik, L. (2012). Speciation of challenging elements in food by atomic spectrometry. *Talanta* 93, 18–31

- Santosh Kumar Bharti, S.K. & Roy, R. (2012) Quantitative ¹H NMR spectroscopy. *Trends in Analytical Chemistry* **35**, 5-26
- Selinus, O., et al. (2005). *Medical geology. Impacts of the natural environment on public health*. Ed. Elsevier, Inc. USA
- Secretaría de Salud. NOM-029-SSA1-1993. Bienes y Servicios. Productos de la pesca. Crustáceos frescos-refrigerados y congelados. Especificaciones sanitarias. Diario Oficial de la Federación, México
- Secretaría de Salud. NOM-129-SSA1-1995. Bienes y Servicios. Productos de la pesca: secos-salados, ahumados, moluscos cefalópodos y gasterópodos frescos-refrigerados y congelados. Disposiciones y especificaciones sanitarias. Diario Oficial de la Federación, México
- Sowell, J. et al (2004). Vitamin C conjugates of genotoxic lipid peroxidation products: Structural characterization and detection in human plasma. *Proceedings of the national academy of sciences* **101**, 17964–17969
- Taylor, A., et al (2006). Atomic spectrometry update. Clinical and biological materials, foods and Beverages. *J. Anal. At. Spectrom.* **21**, 439–491
- Voerkelius, S, et al (2010). Strontium isotopic signatures of natural mineral waters, the reference to a simple geological map and its potential for authentication of food. *Food Chemistry* **118**, 933–940
- Vandecasteele, C. et al. *Modern methods for trace element determination*. Ed. John Wiley & Sons, Ltd., England, 1993

Abbas, H., Ali, F. Study the Effect of Hexavalent Chromium on Some Biochemical, Cytotoxicological and Histopathological Aspects of the *Oreochromis* spp. *Fish. Cell Biol Toxicol* (2012) 28:31–46

Belitz, H., et al. *Food Chemistry*, Ed. Springer, cuarta edición, Alemania 2009, pp 425.

Campbell M, Vermeir G, Dams R., Influence of Chemical Species on the Determination of Mercury in a Biological Matrix (Cod Muscle) Using Inductively Coupled Plasma Mass Spectrometry, *Journal of Analytical Atomic Spectrometry*, 7 (1992), 617-621.

Jiménez, B., *La contaminación ambiental en México*, editorial limusa noriega editores, México, pp 57, 60-60, 111-112, 2004

Rodríguez, M., *Evaluación de metodologías analíticas para la determinación de arsénico en muestras sólidas ambientales*. Tesis de Maestría en Ciencias Químicas, Facultad de Química, Universidad Nacional Autónoma de México. 2001

Shu- Feng C., Shiu-Jen, J., Determination of arsenic, selenium and mercury in fish samples by slurry sampling electrothermal vaporization inductively coupled plasma mass spectrometry, *Journal of Analytical Atomic Spectrometry*, 13 (1998), 673–677.

Türkmen, M., Türkmen, A., Tepe, Y., Töre, Y., & Ates, A. (2009). Determination of metals in fish species from Aegean and Mediterranean Seas. *Food Chemistry*, 113, 233-237.

Zwolak, I., Zaporowska H. Selenium interactions and toxicity: a review. *Cell Biol Toxicol* 28:31–46,

GRACIAS

